

ORDINANCE 16-245

AN ORDINANCE TO AMEND CERTAIN PORTIONS OF TITLE 14 (ZONING AND LAND USE CONTROL) CHAPTER 4 (SIGNS) OF THE CITY OF LAKE LAND'S MUNICIPAL CODE PERTAINING TO, BUT NOT LIMITED TO SIGN ZONES, TEMPORARY SIGNAGE AND CONTENT NEUTRALITY

---

WHEREAS, the City of Lakeland's Municipal Planning Commission/Design Review Commission has reviewed the following edits on February 19, 2015 and recommends said edits; and,

WHEREAS, in accordance with Tennessee Code Annotated, Section 13-7-203 the legislative body held a public hearing to obtain citizen input into said amendment; and,

WHEREAS, said public hearing notice was published in a newspaper of general circulation at least 15 days prior to the aforementioned public hearing.

NOW, THEREFORE, BE IT ORDAINED BY THE BOARD OF COMMISSIONERS OF THE CITY OF LAKE LAND TENNESSEE THAT:

- Section 1. The City of Lakeland Sign Ordinance is hereby amended, as more fully described and illustrated in Exhibit "A" attached hereto.
- Section 2. Subsequent numbering or lettering of subsections will be initiated after deleting or inserting text proposed in this amendment.
- Section 3. The provisions of the Ordinance are severable. If any provision of this Ordinance or the application thereof to any person or circumstance is held to be invalid by a court of competent jurisdiction, such invalidity shall not affect other provisions or applications of this Ordinance that can be given effect without the invalid provision or application.
- Section 4. This Ordinance shall take effect immediately after its final passage, the public welfare requiring it.

First Reading: September 08, 2016  
Public Hearing: October 13, 2016  
Final Reading: October 13, 2016

  
Wyatt Bunker, Mayor

ATTEST:

  
Jessica Millspaugh  
City Recorder

EXHIBIT “A”  
ORDINANCE 16-245

CHAPTER 4  
SIGNS

SECTION

14-401.	Purposes, Applicability and Effect .....
14-402.	Definitions, Interpretations, and Computations. ....
14-403.	Signs Exempt from Regulations.....
14-404.	Permitted Signs: Location, Size, and Number .....
14-405.	Prohibited Signs .....
14-406.	Design and Construction Standards .....
14-407.	Interstate and Highway Corridor Signs.....
14-408.	Administration and Penalties .....
14-409.	Permits and Fees .....
14-410.	Variances.....
14-411.	Inspection, Removal and Safety .....
14-412.	Nonconforming Signs .....
14-413.	Severability .....
14-414.	Effective Date .....
14-415.	Repeal of Conflicting Ordinances.....

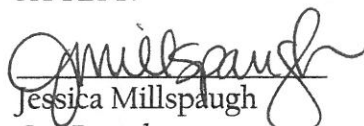
**14-401 Purposes, Applicability and Effect**

(1) **Purposes.** The purposes of these regulations are: to encourage the effective use of signs as a means of communication in the City; to maintain and enhance the pleasing look of the City, which attracts to the City major events of regional interest; to preserve Lakeland as a community that is attractive to business; to improve pedestrian and traffic safety; to minimize the possible adverse effects of signs on nearby public and private property; and to implement relevant provisions of the Comprehensive Plan, as updated from time to time.

In that context, the City continuously invests in parks, landscaping, quality public facilities and other features and amenities that enhance the attractiveness of the community; a major purpose of this ordinance is to ensure that signs in the community are compatible with the high quality image that the City seeks and in which the City continuously invests.

(2) **Applicability.** A sign may be erected, placed, established, painted, created or maintained in the City in conformance with the standards, procedures, exemptions and other requirements of this Ordinance. Signs exempt from regulations under Section 14-403 of this Ordinance, shall not otherwise be subject to this Ordinance.

(3) **Effect.** The effect of this Ordinance, as more specifically set forth herein, is:

(a) To establish a permit system to allow a variety of types of signs in commercial and industrial zones, and a limited variety of signs in other zones, subject to the standards and the permit procedures of this Ordinance;

## ORDINANCE 16-245

(b) To allow certain signs that are small, unobtrusive and incidental to the principal use of the respective property on which they are located, subject to the substantive requirements of this Ordinance, but without requirement for permits;

(c) To provide for temporary signs in limited circumstances;

(d) To prohibit all signs not expressly permitted by this Ordinance;  
and

(e) To provide for the enforcement of provisions of this Ordinance.

### (4) Transitional Provisions.

(a) All holders of permits for signs issued legally prior to ~~June 27, 2003~~ ~~Month, date, year~~ may erect the signs which are the subject of such permits within the times allowed by such permits, and such signs shall then be treated as though they had been erected prior to ~~June 27, 2003~~ ~~Month, date, year~~. However, such permits may not be extended or amended unless the sign that is the subject of such permit will conform to all of the requirements of this Ordinance.

(b) All violations of the sign regulations repealed by the adoption of this Ordinance shall remain violations of the Ordinances of the City and all penalties and enforcement remedies set forth hereunder shall be available to the City as though the violation were a violation of this Ordinance. However, if the effect of this Ordinance is to make a sign that was formerly nonconforming become conforming, then enforcement action shall cease except to the extent of collecting penalties (other than removal of the sign) for violations that occurred prior to ~~June 27, 2003~~ ~~Month, date, year~~

## 14-402 Definitions, Interpretations, and Computations

(1). **Definitions.** The following words, terms and phrases, when used in this chapter, shall have the meanings ascribed to them in this section, except where the context clearly indicates a different meaning.

(a) **Abandoned Sign** – A permitted sign that was erected on the property in conjunction with a particular use, that use having been subsequently discontinued for a period of 30 days or more, or a permitted temporary sign for which the permit has expired.

(b) **Accessory Building or Structure** – A structure detached from a principal building located on the same lot and customarily incidental and subordinate to the principal building or use.

(c) **Animated Sign** – Any sign that uses movement, projection, or change of lighting or other electrical impulses to depict action or create a special effect or scene, except LED displays on restaurant menu boards. Variable display signs, beacons and moving message boards are considered to be animated signs under this article.

(d) **Attention-Attracting Device** – Any device or object visible from any public right-of-way which is primarily designed to attract the attention of the public to a business, institution, sign or activity through such means, including but not limited to illumination, color, size or location. Attention-

## ORDINANCE 16-245

attracting devices or objects oftentimes incorporate illumination, which may be stationary, moving, turning, blinking (including animation) or flashing. Attention-attracting devices may or may not convey a message and can include, but are not limited to, search lights, beacons, strobe lights, strings of lights, barber poles, internally illuminated translucent canopies or panels, electronically controlled message boards (time/temperature signs, gas price signs, public service announcements, etc.), banners, streamers, pennants, propellers and inflatable objects (including strings of balloons) or other device designed to attract attention. Approved traffic-control devices are not considered to be attention-attracting devices.

(e) **Awning** – Any rigid or non-rigid material, such as metal, fabric, or flexible plastic that extends from the exterior wall of a building and is supported by or attached to a frame.

(f) **Awning Sign** – A sign located on an awning.

(g) **Background Area** – The entire area of a sign on which copy could be placed, as opposed to the copy area, where copy is in fact posted or painted (see also “Face of Sign”).

(h) **Backlighting (Back lit) Sign** – A sign consisting of a cabinet containing a light source surrounded by one or more translucent faces.

(i) **Banner** – Any sign printed or displayed upon cloth or any other flexible material, with or without frames or insignia.

(j) **Beacon** – Any light with one or more beams regardless of intensity directed into the atmosphere or directed at one or more points not on the same site as the light source; also, any light with one or more beams that rotate or move.

(k) **Building Marker** - Any sign indicating the name of a building and date and incidental information about its construction. Such sign typically is cut into a masonry surface or made of bronze or other permanent material.

(l) **Code Enforcement Official** - A person designated by the City Manager or Manager’s designee to administer and enforce the provisions of this Ordinance.

(m) **Building Permit** – A permit issued by Shelby County or the City of Lakeland pursuant to codes adopted by Shelby County and the City of Lakeland, Tennessee.

(n) **Building, Principal** - A building that contains the principal activity or use located on a lot.

(o) **Building Sign** - Any sign attached to any part of a building, as contrasted to a “ground sign.”

(p) **Building Wall** - An exterior load-bearing or non-load-bearing vertical structure that encompasses the area between the final grade elevation and eaves of the building, and used to enclose the space within the building. A porch, balcony or stoop is part of the building structure and may be considered as a building wall.

(q) **Campaign Sign** – A sign expressing support for a candidate for public office or another position regarding a public figure or issue, but bearing no commercial message.

## ORDINANCE 16-245

(r) **Canopy** - A roof structure constructed of rigid materials, including but not limited to, metal, wood, concrete, plastic, or glass, which is attached to and supported by a building, or which is free-standing and supported by columns, poles or braces extended from the ground. Unlike a marquee, a canopy generally has very limited vertical surface area; and unlike an awning, a canopy is generally supported by vertical elements rising from the ground at two or more corners.

(s) **Canopy Sign** Any sign that is a part of or attached to a structural protective cover over a door, entrance, window or outdoor service area. A marquee is not a canopy sign.

(t) **Changeable Copy Sign (Manual)** - Any sign designed so that letters or numbers attached to the sign can be periodically changed manually to indicate a different message.

(u) **Changing sign (automatic)** - A sign, such as an electronically or electrically controlled public service time, temperature and date sign, message center or reader board, where different copy changes are shown on the same lamp bank.

(v) **Channel Letter** -The outline of a letter, with metal sidewalls into which a neon tube, fiber optics or LED's are placed. A channel letter's sign prevents the neon from having a run together appearance. The depth of the channel letter may vary. Variations include: open channel letter, reverse channel letter, and front and back lit letters.

(w) **Charitable/Nonprofit Event** - An event which takes place entirely or partially within the City of Lakeland and the organization holding the event is classified as a nonprofit or charitable organization.

(x) **Commercial Message** - Any sign, wording, logo, or other representation, except for the actual name of the business, that, directly or indirectly, names, advertises or calls attention to a business, product, service or other commercial activity.

(y) **Construction Sign** - Any sign bearing the names of contractors, architects, engineers, and the like, or advertising, promotions, price ranges and similar information, that is placed at a construction site that has received development plan approval from the City of Lakeland.

(z) **Copy** - The wording and advertising display on a sign surface.

(aa) **Copy Area** -The area in square feet of the smallest geometric figure that describes the area enclosed by the actual copy of the sign. For wall or canopy sign, the copy area limits refer to the message and the illuminated background.

(bb) **Directory Sign** -A ground or building sign that lists tenants or occupants of a building or project, with unit numbers, arrows or other directional information.

(cc) **District** -Any section of the City for which the zoning regulations governing the use of buildings and property, the height of buildings, the size of yards and the intensity of uses are uniform.

(dd) **Double-faced "V" type back to back signs** - Those configurations or multiple sign structures, as those terms are commonly understood. In no instance shall these terms include two or more signs which are

## ORDINANCE 16-245

not physically contiguous or connected by the same structure or cross-bracing or, in the case of the back-to-back or “V” type signs, located no more than three (3) feet apart at their point of connection.

(ee) **Erected** - Attached, altered, built, constructed, reconstructed, enlarged or moved.

(ff) **Exempt Sign** - Any sign which is exempt from the permit requirements established herein.

(gg) **Existing Sign** - Any sign lawfully erected, mounted or displayed prior to adoption of this Ordinance.

(hh) **Face of Sign** - The entire area of sign on which copy could be placed; the area of a sign which is visible from one direction as projected on a plane (see also “Background Area”).

(ii) **Finished Grade** - The elevation of the land surface of a site after completion of all site preparation work.

(jj) **Flashing Sign** - A sign which contains an intermittent or flashing light source, or which includes the illusion of intermittent or flashing light by means of animation, or an externally mounted light source. A sign, the illumination of which is not constant in intensity when in use, and which exhibits sudden and marked changes in lighting effects. A sign that automatically and periodically changes its message more than once per day shall be considered a flashing sign under this Ordinance. LED displays on restaurant menu boards are not considered flashing signs.

(kk) **Ground Sign** - A sign attached to the ground, as contrasted to a “building” sign.

(ll) **Ground Sign, Principal** - A sign that is permanently attached to the ground and is the primary identifier of the property from adjacent public rights-of-way or private properties and meets the requirements of this Ordinance, but not including a ground sign that conforms to the definition of “incidental sign.”

(mm) **Holiday Decorations** - Displays erected on a seasonal basis in observance of religious, national or state holidays, which are not intended to be permanent and contain no advertising material or commercial message.

(nn) **Identification Sign** - A sign bearing the address of the premises or name of occupant, but containing no logo or commercial message.

(oo) **Illegal Sign** - A sign that contravenes this chapter, or a nonconforming sign for which a permit required under a previous ordinance was not obtained.

(pp) **Illuminated Sign (Internally)** - A sign that transmits light through its face or any part thereof.

(qq) **Incidental Sign** - A sign, generally informational, that has a purpose secondary to the use of the site on which it is located, such as “no parking,” “entrance,” “loading only,” “telephone,” and similar information and directives. No sign with a commercial message legible from a position off the site on which the sign is located shall be considered incidental.

(rr) **Institutional Sign** - A sign bearing a message related to an institutional use, where such sign is located on the same premises as such use.

ORDINANCE 16-245

(ss) **Institutional Use** - For the purpose of determining allowable signage, a primary or secondary school (public or private), college or university including extension facilities, religious institution, or other use operated by a public agency or nonprofit organization and permitted as a use in one or more residential zoning districts of the City. **A daycare facility shall not be considered an institution regardless of ownership or operation.** \*\*\*\*\*

~~(tt) **Interior Property Line** - A property line other than that forming a dedicated public right of way.~~

(uu) **Interstate Sign** - A monument-style sign **not exceeding 35 feet in height and a sign area of 100 square feet per face** located on a parcel zoned commercial and also having no less than 1,000 linear feet of lot frontage upon directly upon the right-of-way of Interstate 40 and installed in accordance with Section 14-407.1 of this Ordinance. \*\*\*\*\*

(vv) **Landscaped Area** - A portion of the site or property containing vegetation to exist after construction is completed. Landscaped areas include, but are not limited to, natural areas, buffers and screening measures, streetscapes, lawns and plantings.

(ww) **Lighting** - The method or manner by which a sign is illuminated during the period from thirty (30) minutes prior to sundown and thirty (30) minutes after sunrise.

(xx) **Logo** - The graphic or pictorial presentation of a message, including, but not limited to, the use of shapes, designs, decorations, emblems, trademarks, symbols or illustrations, or the superimposition of letters or numbers or any other use of graphics or images other than the sequential use of letters and numbers.

(yy) **Lot** - A parcel of land whose boundaries have been established by some legal instrument, such as a recorded deed or plat, and which is recognized as a separate legal entity for purposes of transferring title. This term shall include any number of contiguous lots, or portions thereof, upon which a single principal building and its accessory buildings are located or intended to be located.

~~(zz) **Lot of Record** - A lot that is part of a subdivision approved and recorded in accordance with rules and regulations of the City of Lakeland.~~

(aaa) **Marquee** - A roof-like structure that cantilevers from the wall of a building over its principal entrance that has no vertical supports other than the wall from which it cantilevers, **and that provides a wall surface at least four (4) feet high.** \*\*\*\*\*

(bbb) **Marquee Sign** - A sign attached to or mounted to or on top of a marquee.

(ccc) **Menu Board** - An accessory sign providing items and prices associated with a drive-thru window.

(ddd) **Model Home Sign** - A temporary sign designating a furnished model home.

(eee) **Neon** - A tasteless, colorless, inert gas - When an electric current is discharged through it, neon produces a reddish-orange glow. Neon is also used synonymously with a type of luminous tube sign where a glass tube is bent to a desired shape, fitted with an electrode at each end, the atmosphere is pumped

ORDINANCE 16-245

and burned out, and the resulting vacuum is filled with a rare gas, such as neon, helium, argon, mercury vapor or a combination of gases.

(fff) **New Project Real Estate Sign** - A sign **not exceeding 25 square feet per face**, announcing space available for sale, rent or lease within a new project or a project having undergone renovation efforts equal to 25 percent of its value. \*\*\*\*\*

(ggg) **Nonconforming Sign** - A sign erected or otherwise in use that met the requirements of the City at time it was erected or otherwise put in use, but does not conform to the requirements of this Ordinance.

(hhh) **Off-Premise Sign (Off-Site Sign)** - A sign that directs attention to a business, commodity, or service offered at a location other than the premises on which the sign is erected. Any sign that is not an on-premise sign as defined herein shall be considered an off-premise sign.

(iii) **On-Premise Sign (On-Site Sign)** - A sign that directs attention to a business, commodity or service located or offered on the premises on which the sign is erected. For the purpose of this Ordinance, common access easements, common reserved areas or common open space shall be considered **any of the served lots as part of the premises on which the sign is erected.**

(jjj) **Opaque** - Not clear or translucent - Not allowing light to show through

(kkk) **Open Channel Letter** - A channel letter which has no face and in which the neon tubing is visible.

(lll) **Owner** - A person recorded as such on official records and including duly authorized agent or notary, a purchaser, a devisee, judiciary; any person having a vested or contingent interest in the property in question.

(mmm) **Pennant** - Any lightweight plastic, fabric or other material, whether or not containing a message of any kind, which is suspended from a rope, wire, string or pole, usually in series, and which is designed to move in the wind.

(nnn) **Person** - Any association, company, corporation, firm, organization or partnership, singular or plural, of any kind.

(ooo) **Pole Sign** - A sign mounted upon the ground but which by reason of height, width or other characteristics does not qualify as a "principal ground sign", characterized by a free standing exposed frame, mast or pole and not attached to any building.

(ppp) **Political Sign** - A sign attracting attention to political candidates or issues.

(qqq) **Portable Sign** - Any sign not permanently attached to the ground or other permanent structure or a sign designed to be transported, including, but not limited to, signs designed to be transported by means of wheels; signs made as A-frames or T-frames; balloons used as signs; umbrellas used for commercial messages; and signs attached to or painted on vehicles or trailers parked and visible from the public right-of-way.

(rrr) **Portico** - A porch or walkway, open to the outside air that is covered by a roof supported by columns or pillars, typically leading to the entrance of a building. A portico is considered a "canopy" for purposes of determining signage.



## ORDINANCE 16-245

(sss) **Poster Box** - A box installed on a wall for the purpose of displaying posters of shows at a theater.

(ttt) **Premises** - An area of land with its appurtenances and buildings which, because of its unity of use, may be regarded as the smallest conveyable unit of real estate.

(uuu) **Prohibited Sign** - Any sign, other than nonconforming sign, which does not comply with this Ordinance or is specifically restricted herein.

(vvv) **Project** - A commercial or mixed-use center containing a combination of retail, office, and/or other uses located on a single parcel or multiple parcels. A project is included within a single plat, site plan, or planned development application.

(www) **Project Sign** - A sign identifying a multi-tenant property.

(xxx) **Projecting Sign** - Any sign attached to a building wall extending laterally more than eighteen (18) inches from the face of such wall.

(yyy) **Public Event Banner** - Any sign of lightweight fabric or similar material, except for national, state, municipal or official flags of any institution, that is mounted to a pole or building by a supporting frame at two or more edges.

(zzz) **Raceway** - A metal structure enclosing the electric components of a sign.

(aaa) **Real Estate Sign** - A sign advertising real property for sale or for lease.

(bbbb) **Real estate information tube/box** - A box or tube attached to one end of the temporary real estate sign for the purpose of holding a brochure whose information relates to the subject property. The dimensions of the box shall be a maximum ten inches by 14 inches by three inches, and the tube shall be a maximum 12 inch by three-inch diameter. The box and the tube shall be black or white in color, or translucent. Advertising on the exterior of the box or tube shall be prohibited.

(cccc) **Real estate window signs** - A sign located inside a window offered for sale, rent, or lease for the purpose of announcing such.

(dddd) **Residential Sign** - Any sign located in a district zoned for residential uses that contains no commercial message.

(eee) **Reverse Channel Letter Sign** - A sign composed of channel letters which have face and sides, but no back and are pegged out from a background surface (wall). When the light source inside the letter is lit, it produces a halo-effect around the letter.

(fff) **Right-of-way (R. O. W.)** - The proposed right-of-way as indicated on the official city major street plan and/or as set forth in the city subdivision ordinance.

(ggg) **Roof Line** - The highest horizontal point of the wall visible to the public, excluding any architectural feature which extends above such apparent horizontal roof line if such feature is fully enclosed and considered an integral part of the occupied space such as an atrium or high ceiling.

(hhh) **Roof Sign** - A sign erected wholly or partially above the roofline.

(iii) **Rotating Sign** - Any sign or portion of a sign that moves in a revolving or similar manner.

## ORDINANCE 16-245

(jjjj) **Seasonal or Special Occasion Sign** – A sign that is not permanently attached and is limited to a specific activity or in the celebration of holidays or other special events for a specified period of time.

(kkkk) **Setback** - A line running parallel to the front, side and rear property lines that establish the minimum distance the principal building and related appurtenances including parking, signage, and accessory buildings, must be from each respective property line measured in feet.

(llll) **Shopping Center** - A building or group of buildings, either connected or free-standing, under unified or multiple ownership of land parcels, that is designed and has been approved by the City of Lakeland as a shopping center with common parking, pedestrian movement, common ingress and egress, and used or intended to be used primarily for the retail sale of goods and services to the public.

(mmmm) **Shopping Center Sign** - A ground mounted sign that may contain the name of the shopping center and/or individual tenants. \*\*\*\*\*

(nnnn) **Sign** - Any device, fixture, placard or structure that uses any color, form, graphic, illumination, symbol or writing to advertise, announce the purpose of, or identify the purpose of a person or entity, directs attention to a product, service, place, activity, person, institution, business or solicitation, including any permanently installed or situated merchandise, which is exposed to the view of potential clients or customers and/or the general public, and is located on public or private property, inside or outside of buildings, or to communicate information of any kind to the public, except the following:

- i. Merchandise temporarily displayed in a show window available for sale on the premises and that does not include flashing, neon, or colored lights;
- ii. Decorative devices or emblems as may be displayed on a residential mailbox.

(oooo) **Sign Plan** - A plan prepared to scale conforming to submittal requirements contained in this Ordinance that depict construction details for all types of signage proposed for installation on a parcel.

(pppp) **Sign Structure** - Any structure that supports or has supported or is capable of supporting a sign, including decorative cover.

(qqqq) **Site** - A lot, tract or parcel of land considered as one land-unit for purposes of this Ordinance. For a single-family residence, the site shall be the subdivided lot on which it is located. For multifamily projects, the site shall be all land occupied by the buildings in the project and adjoining such property and under common ownership with it. For vacant land, the site shall be all of the adjoining vacant land under single ownership. For single-occupancy, non-residential properties, the site shall be the subdivided lot that is occupied. For multiple-occupancy properties, the site shall be all land included under the original “site plan” or “subdivision plan” approved by the City of Lakeland.

(rrrr) **Site Plan** - A scaled graphic schematic of a development site indicating the location of buildings, walkways, signage, lighting, parking, drainage facilities, topography and landscaping, as they are to appear upon the completion of development. Site plans may be required to contain such other

## ORDINANCE 16-245

information as may be deemed necessary by the Design Review Commission to insure proper development of the site.

(ssss) **Site Triangle (or Horizontal Sight Distance)** - The horizontal and vertical areas at the intersections of streets and/or driveways which must remain unobstructed in order to ensure that drivers can see traffic and pedestrians around the corner of the intersection, entrance or driveway.

(tttt) **Snipe Sign** - Any sign that is affixed by any means to trees, utility poles, fences or other objects, where the message appearing thereon is not applicable to the present use of the premises upon which the sign is located.

(uuuu) **Street** - A publicly maintained right-of-way, other than an alley, which affords a primary means of access to abutting property. The word "street" shall include the words "road", "highway", and "thoroughfare". For the purpose of these regulations, streets are divided into the following categories:

- i. **Street, Arterial** - A major street used primarily for heavy through traffic.
- ii. **Street, Collector** - A street designed to carry traffic from minor streets to the major road system, including the principal entrance streets to a residential development and the streets for major circulation within such a development.
- iii. **Street, Cul-de-sac** - A short, local street having an outlet at one end and having the other end permanently closed and designed with a circular turnaround; not intended to be extended in the future.
- iv. **Street, Dead-end** - A street temporarily having only one outlet for vehicular traffic, with one end terminating at the edge of undeveloped property, with the intent to extend the street at some point in the future.
- v. **Street, Local** - A neighborhood street that provides access to abutting properties and is designed to carry traffic from residential areas to collector streets.
- vi. **Street, Marginal Access** - A minor street which is constructed parallel and adjacent to an arterial street for the purpose of providing access to abutting properties and protection from through traffic.

(vvvv) **Street Frontage** - The distance for which a lot line adjoins a public or private street from one lot line intersecting said street to the furthest lot line intersecting the same street.

(wwww) **Subdivision Entrance Sign** - A sign that gives the name of a residential or non-residential subdivision or multifamily development.

(xxxx) **Suspended Sign** - A sign that is suspended from and supported by the underside of a horizontal plane surface.

(yyyy) **Swinging Sign** - A hinged sign installed on an arm, spar, mast or similar appendage that is not, in addition, permanently fastened to an adjacent wall or upright pole.

(zzzz) **Tag Sign** - Secondary signs that are descriptive of goods and services available on the premises such as "Deli/Bakery" and "Open 24 Hours".

## ORDINANCE 16-245

(aaaaa) **Temporary sign** - Any sign that used only temporarily and sign is not permanent mounted, and that is allowed only for a designated time period.

(bbbbb) **Traffic Sign** - A sign indicating federal, state, or municipal regulations for vehicular or pedestrian movement.

(ccccc) **Translucent** - The property of a material to allow the passage of some light through it without being transparent.

~~(ddddd) **Tubular lighting** - Lighting such as, but not limited to, neon, gas, fiber optics, or other similar forms of lighting, installed on an exterior building facade, canopy, awning, architectural feature, or any other structural component of the building outside the area of any allowable wall signs, for the purpose of drawing visual attention to the business.~~

(eeee) **Two-sided Sign or Two Sign Faces** - Any sign constructed on a single set of supports with messages visible on either side, or a “V” type sign with a common support in the center of the “V”.

(ffff) **Use** - The purpose for which a building, lot, sign or other structure is arranged, intended, designed, occupied or maintained.

~~(ggggg) **Vending machine sign** - Any lighted device used to dispense goods or products by either mechanical or manual operation by coin.\*\*\*~~

(hhhhh) **Wall, Exterior** - A vertical, structural component of a building which encloses habitable or usable space; a parapet extending not more than twelve (12) inches above a flat roof shall be considered part of the exterior wall for purposes of determining signage.

(iiii) **Wall sign** - Any sign painted on or attached to and extending not more than 12 inches from an exterior wall in a parallel manner.

(jjjjj) **Windblown Device** - Any banner, pennant, spinner, streamer, propeller, disc, moored blimp, gas balloon or flag (which is not of local, state, federal, corporate, nonprofit or religious origin) that is designed to inform or attract attention, whether or not such device carries a message, all or part of which is set in motion by wind, mechanical, electrical or any other means.

(kkkkk) **Window Sign** - Any sign that is applied to the inside or outside of glassed areas of a building or within one (1) foot of the window.

(2). **Interpretations.** Words and phrases used in this Ordinance shall have the meanings set forth in this Article. Words and phrases not defined in this Ordinance, but defined elsewhere in the City Code shall be given the meanings set forth there. Principles for computing sign area and sign height are given in the next section. All words and phrases shall be given their common, ordinary meanings, unless the context clearly requires otherwise. Section headings or captions are for reference purposes only and shall not be used in the interpretation of this Ordinance. Illustrations included in the code shall be used in interpreting the relevant provisions, but where the text conflicts with an illustration the text shall control.

### (3) Computations.

~~(a) **Area Computation of Individual Signs:** - The area of a sign face (which is also the sign area of a wall sign or other sign with only one face) shall be computed by means of the smallest rectangle that will encompass the extreme limits of the writing, representation, emblem or other display, together with any material or color forming an integral part of the background of the~~

ORDINANCE 16-245

display or used to differentiate the sign from the backdrop or structure against which it is placed calculated by enclosing the extreme limits of all lettering, background, emblem, logo, representation, or other display within a single continuous perimeter composed of squares or rectangles with no more than eight lines drawn at right angles, but not including any supporting framework, base, bracing or decorative fence or wall when such fence or wall otherwise meets the regulations of this Ordinance and is clearly incidental to the display itself. For a single wall on a single-occupant building, all pieces of information or other graphic representations on that wall shall be measured as though part of one sign, encompassed within one rectangle, which may not exceed the maximum permitted sign area. For a single wall on a multi-occupant building, the area of signs shall be computed based on individual occupant signage, using these principles, but only the number of signs on the approved sign plan shall be permitted on each wall.

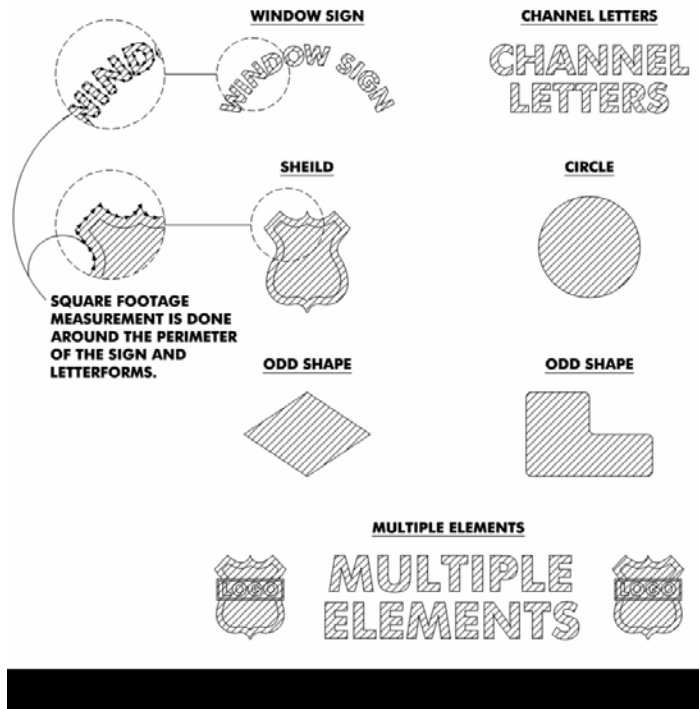

Deleted Illustration

Figure 1: Area Computation of Sign of Individual Signs

(a) Area Computation of Individual Signs: The area of a sign comprised of individual letters or elements attached to a building wall is determined by calculating the area of the smallest geometric figure (e.g. square, rectangle, circle, polygon, etc.) that can be drawn around the letters and/or elements.

Signs consisting of individual letters and/or elements will be measured as one sign when the distance between the letters and/or elements is less than the largest dimension of the largest sign letter.

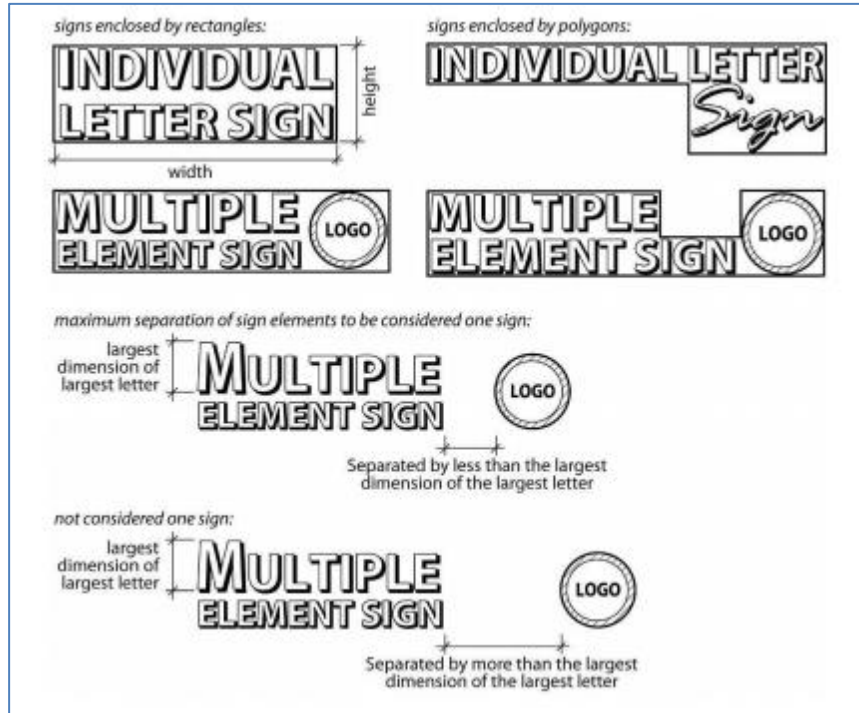

Figure 1: Area Computation of Sign of Individual Signs

(b) Area Computation of Multi-Faced Signs: Where the sign faces of a double-faced sign are parallel, only one display face shall be measured in computing sign area. If the two faces of a double-faced sign are of unequal area, the area of the sign shall be the area of the larger face. In all other cases, the areas of all faces of a multi-faced sign shall be added together to compute the area of the sign. Sign area of multi-faced signs is calculated based on the principle that all sign elements that can be seen at one time or from one vantage point should be considered in measuring that side of the sign.

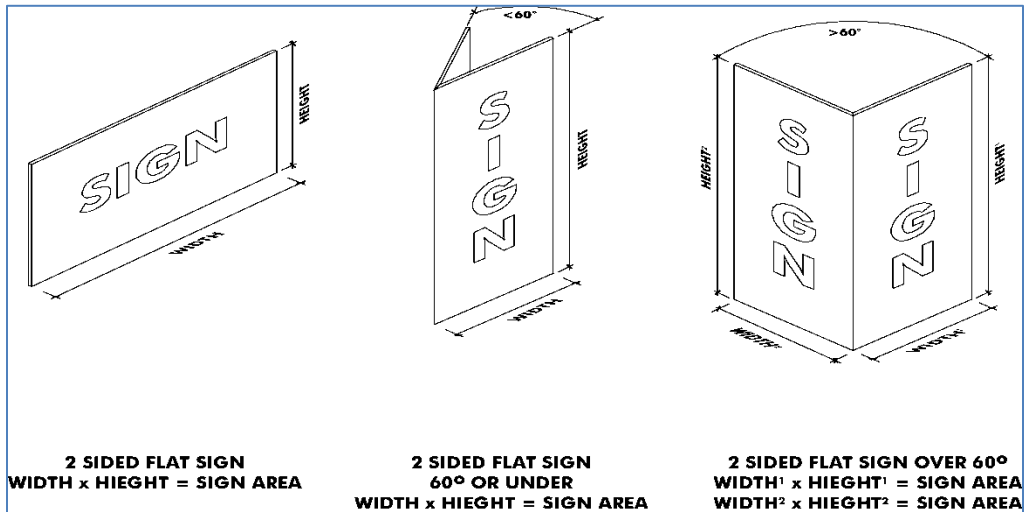

Figure 2: Area Computation of Multi-Faced Signs

(c) Sign Height Computation: The height of a sign shall be computed as the distance from the base of the sign at normal grade to the top of the sign

ORDINANCE 16-245

the highest attached component of the sign. Normal grade shall be construed to be the newly established grade after construction, exclusive of any filling, berming, mounding or excavating solely for the purpose of locating the sign. In cases where the normal grade is below grade at street level, sign heights shall be computed on the assumption that the elevation of the normal grade at the base of the sign is equal to the elevation of the nearest point of the crown of a public or private street.

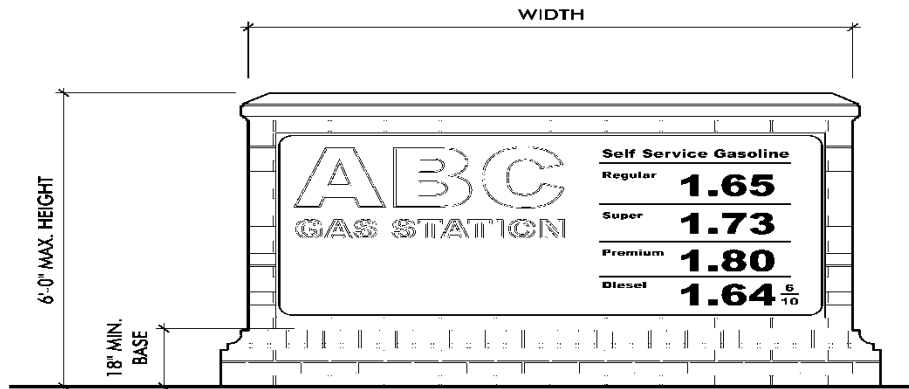

Figure 3: Sign Height Computation

(d) Building Frontage: Building frontage shall mean the horizontal length of a building on the side with its principal entrance. If that side is a straight wall, then the building frontage shall be the length of the wall. If the side is not a straight wall, the building frontage shall be the horizontal distance from the corner at one end of the side of the building with the principal entrance to the other corner on the same side of the building; where that side of the building is concave, then the measurement shall be made in a straight line from corner to project in front of the front corners, then the measurement shall be made as the shortest distance between two lines projected from the two front corners of the building, with such lines parallel to each other and as close as practicable to perpendicular to the front of the building.

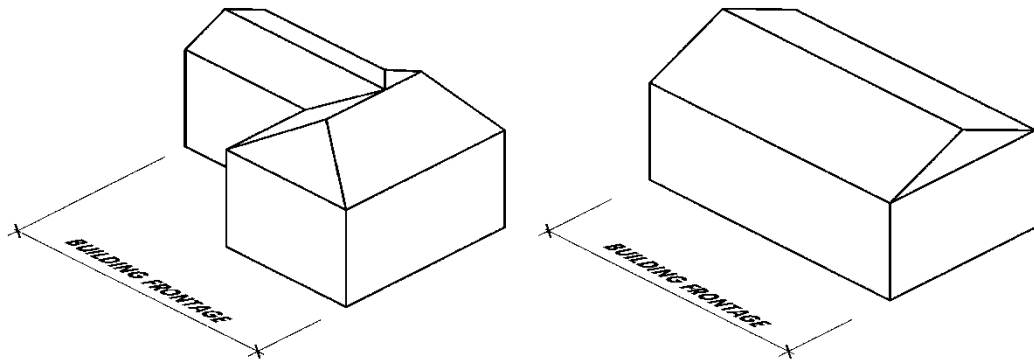

Figure 4: Building Frontage Measurements

## ORDINANCE 16-245

### 14-403. Signs Exempt from Regulations.

The following signs shall be exempt from regulations under this Ordinance:

(1) Any official or public notice or warning required by a valid and applicable federal, state or local law, regulation or ordinance, by a public utility company or by order of a court of competent jurisdiction;

(2) Traffic signs on private property, such as Stop, Yield and similar signs, which meet Department of Transportation and Manual on Uniform Traffic Control Devices standards and contain no commercial message;

(3) Government signs for the control and direction of traffic and other regulatory purposes;

(4) Historic markers recognized by local, state and/or federal authorities;

(5) Memorial plaques, cornerstones, historical tables and the like;

(6) Address signs denoting the numerical address designation of the premises on which the sign is placed not to exceed 72 square inches in surface area.

(7) Any sign inside a building, not attached to a window or door, that is not visible from off the site on which it is located;

(8) Decals, numerals, names, addresses, hours of operation, credit information, etc., attached to a door or window and all of which occupy a total surface area not to exceed three (3) square feet; provided, however, street numbers and addresses shall not be included in calculating the total surface area;

(9) Any sign inside an athletic field or other enclosed outdoor space, where the sign is not legible from more than three (3) feet beyond the lot line of the site on which it is located;

(10) Hand carried signs;

(11) Signs affixed to vehicles and trailers used in the normal transport of goods or persons where the sign is incidental and accessory to the primary use of the vehicle or trailer.

(12) Works of art with no commercial message; and

(13) Special event signs for community events sponsored in whole or part by the City of Lakeland.

(14) Incidental signs on the interior of a property not generally readable from off the property.

(15) Window signs not exceeding 25% up to a maximum of six (6) square feet of the transparent portion of a commercial building façade.

### 14-404 Permitted Signs: Location, Size and Number

(1).— Table of Permitted Signs. Signs shall be permitted in accordance with Table 1, subject also to the provisions of any sign plan approved by the Design Review Commission applicable to the site, subject to the conditions attached to Table 1 by reference number, and subject to the height limits shown in Table 2. The characters



ORDINANCE 16-245

“NP” in the row for a sign and in the column for a particular group of zoning districts shall indicate that the sign is allowed in that district without a permit; the characters “SP” in the row for a sign and in the column for a particular group of zoning districts shall indicate that the sign is allowed in those districts only upon issuance of a sign permit; and “X” in any cell indicates that the type of sign indicated is not allowed in that group of zoning districts under any circumstances; a number in the “Conditions” column for a particular type of sign shall refer to the same numbered “Condition” on the following pages, which shall apply to that sign in accordance with its terms.

**Table 1: Permitted Signs**

Sign Type	Residential Districts	Commercial Districts	Industrial District	Planned Developments	Conditions (see Section 14-404.2)
<b>Ground</b>					
Changeable Copy	SP	SP	X	SP	(2), (21)
Construction	SP	SP	SP	SP	(3)
Directory	X	SP	SP	SP	(4)
Incidental	NP	NP	NP	NP	(7)
Institutional	SP	SP	SP	SP	(8)
Menu Board	X	SP	SP	SP	(9)
Model Home	SP	X	X	SP	(10)
Political	SP	SP	SP	SP	(11)
Principal Ground	SP	SP	SP	SP	(12)
Real Estate	NP	NP	NP	NP	(14)
Residential Real Estate	NP	X	X	NP	(15)
Subdivision Development	SP	SP	X	SP	(22)
Subdivision Entry	SP	SP	SP	SP	(16)
Yard Sale	NP	NP	NP	NP	(20)
<b>Building</b>					
Building Marker	NP	NP	NP	NP	(1)
Changeable Copy	SP	SP	X	SP	(2), (21)

ORDINANCE 16-245

Construction	SP	SP	SP	SP	(3)
Directory	SP	SP	SP	SP	(4)
<b>Sign Type</b>	<b>Residential Districts</b>	<b>Commercial Districts</b>	<b>Industrial District</b>	<b>Planned Developments</b>	<b>Conditions (see Section 14-404.2)</b>
Gasoline Trade	X	SP	X	SP	(21)
Identification	NP	NP	NP	SP	(6)
Incidental	NP	NP	NP	NP	(7)
Residential Real Estate	NP	X	X	SP	(15)
Suspended Sign, Planned Commercial	X	SP	X	SP	(25)
Temporary	SP	SP	SP	SP	(17)
Wall	SP	SP	SP	SP	(18), (19)
Other					
Public Event Banner	SP	SP	SP	SP	(13)
Yard of the Month	NP	NP	NP	NP	(24)
Flag and Flagpole	NP	SP	SP	SP	(5)
Interstate	X	SP	X	SP	See Section 14-407.1
Highway 64 Corridor	X	SP	X	SP	See Section 14-407.2

NP — Signs or other devices allowed without a sign permit.

SP — Signs or other devices allowed after approval of DRC and/or issuance of a sign permit.

X — Signs or other devices not allowed in these zoning districts.

(2) Conditions.

(a) Building Marker. Building marker signs shall be allowed provided that:

- (i) Such signs shall not exceed three (3) square feet in sign area;
- (ii) Such signs shall contain no logo or commercial message;

## ORDINANCE 16-245

- (iii) Such signs shall be made of permanent material, such as bronze or masonry, and be permanently affixed to the building wall; and
  - (iv) Such signs shall not exceed one on any single building.
- (b) Changeable Copy Sign - Changeable copy signs shall be allowed only at schools, public performing arts and recreation facilities, libraries, theater, and places of worship, provided that:
- (i) Only one (1) double-faced ground mounted sign is permitted on any parcel occupied by a school, public performing arts and recreation facility, library or place of worship;
  - (ii) The sign must contain a black background with white letters of sufficient size to be viewed from the public right-of-way;
  - (iii) Such signs shall not exceed 72 inches in height measured from finished grade;
  - (iv) Such signs shall not exceed 32 square feet in sign area per side;
  - (v) Such signs shall be set back a minimum of 20 feet from the edge of the public street right-of-way;
  - (vi) Such signs shall be oriented to the middle of the front property line unless in conflict with an entrance but, in no case shall be placed within 15 feet of a side property line oriented perpendicular to the front property line
  - (vii) The sign shall not be internally illuminated but, may be externally illuminated using a single white light source mounted on the ground with appropriate shields to minimize glare;
  - (viii) The sign shall be placed upon a masonry base a minimum of 18 inches in height measured from finished grade;
  - (ix) The base surrounding the sign shall be landscaped with a combination of evergreen plantings and seasonal colors and such landscape areas shall be irrigated;
  - (x) For a single-occupant school, performing arts and recreation facility, library, or place of worship, only one (1) changeable copy sign shall be permitted and shall only be permitted in lieu of the principal ground sign for the facility;
  - (xi) For a single-occupant school, performing arts and recreation facility, or place of worship that installs a changeable copy sign, no other wall sign or principal ground sign shall be permitted on the premises unless otherwise provided in this Ordinance;
  - (xii) A service station may use up too one-half (1/2) of the area of its principal ground sign or one-half of the area of any wall sign for changeable copy displaying current fuel prices; and,

## ORDINANCE 16-245

(xiii) A theater shall be permitted to have one poster box for each theater viewing room within the theater, subject to total sign area limits applicable to all wall signs, provided that:

- (A) Lighting shall be backlit or internally illuminated;
- (B) Such boxes shall not exceed 36 by 54 inches each in area;
- (C) The top of such boxes shall not be more than eight (8) feet above the ground; and
- (D) Such boxes shall be permanently mounted to a wall.

(c) Construction Sign. Construction signs shall be allowed provided that:

(i) For non-residential, institutional or multifamily residential buildings, in the same location and subject to the same size and other conditions applicable to principal ground sign, ~~except that the limit on the number or color of pieces of information shall not apply to the construction sign~~. Such sign shall be removed no later than the date of the issuance of the Certificate of Occupancy for the premises or any part thereof.

(ii) For new single-family residences, a single sign of not more than 36 inches in height measured from finished grade and 4 square feet in sign area shall be permitted ~~containing information about the construction or financing of the residence~~. Such sign shall be removed upon issuance of a Final Inspection and/or Certificate of Occupancy.

(iii) In single-family residential districts, including planned unit developments allowing single-family residences, a single construction ground sign shall be permitted as an accessory use to a subdivision real estate sales office, as long as such office is permitted in the Zoning Ordinance and actually used. Such sign shall not exceed 16 square feet in sign area and 48 inches in height measured from finished grade.

(iv) Construction signs shall not be permitted on existing single-family residences, ~~except that a sign saying "construction entrance" or if providing directional or safety related information may be placed on the single-family residential site, subject to the conditions applicable to "residential sign", including the prohibition of commercial messages, a height limit of 48 inches measured at finished grade and an area limit of four (4) square feet per side.~~

(d) Directory Sign. Directory ground-mounted signs not visible from the public right-of-way shall be allowed where a particular building or structure includes more than six (6) tenants and a minimum gross floor area of 100,000 square feet, provided that:

(i) Logo/name directory signs in shopping centers may be located near entrances to parking areas, but not less than 100 feet from any public right-of-way, and at principal intersections within the site,

## ORDINANCE 16-245

where such intersections are not less than 100 feet from any public right-of-way.

(ii) Such signs shall not exceed 16 square feet in area and 48 inches in height measured from finished grade, subject to the total sign area requirements for ground signs allowed for the development.

(iii) Such signs may contain logos or business names with arrows or other directional information but, shall not contain any commercial message.

(iv) Such sign shall not be separately illuminated.

~~(v) Such sign shall contain no more than six (6) pieces of information including the name of the development.~~

(e) Flag and Flag Pole. Flags and flagpoles shall be allowed, provided that:

(i) Sites Not Showing Flags and Flagpoles on Site Plans. On a non-residential or multi-family residential site not showing flags on an approved site plan, there shall be no more than three (3) flagpoles and two (2) flags per pole. Poles for such flags shall be located on the principal building wall on the site or within twenty (20) feet of the main building entrance. No flag shall bear a commercial message;

(ii) Sites Showing Flags and Flagpoles on Site Plans and Sign Plan. Flags may be included on a site plan and located as shown on that plan, provided that:

A. Flagpoles shall be limited to three (3) per principal building or multi-family residential complex;

B. No flag shall bear a commercial message; and

C. Flagpoles shall be not less than fifty (50) feet from a public or private street right-of-way;

(iii) Flags on Single-Family Residential Lots. There shall be not more than one (1) flagpole and two (2) flags per pole on any single-family residential lot. No flag shall bear a commercial message. No sign on such lot may bear a commercial message;

(iv) Flag Size – All Sites. No flag shall exceed five (5) feet by eight (8) feet in size; and

(v) Flagpole Height – All Sites. No flagpole shall exceed twenty-five (25) feet in height measured from finished grade.

(f) Identification Sign. Identification signs shall be allowed provided that:

(i) Such signs shall be limited to one (1) per principal building entrance;

ORDINANCE 16-245

- (ii) Such signs shall not exceed three (3) square feet in sign area;
  - (iii) Such signs shall contain no logo or commercial message;
- and,
- (iv) Such signs shall be affixed to a building wall.

(g) Incidental Sign. Incidental signs shall be allowed provided that they contain no commercial message or logo and do not exceed one (1) square feet in area placed a minimum of ten (10) feet from the front property line, except that signs providing notice that cars parked illegally may be towed may comply with provisions of applicable state and federal law where such provisions may require that such notice be placed on larger sign placards. Incidental ground signs shall not exceed twenty-four (24) inches in height measured from finished grade.

(h) Institutional, Temporary. Religious institutions shall be allowed temporary signs for special events, such as revivals, guest speakers, season festivals, vacation bible school, fund-raising events, and other related events, provided that:

- (i) Only one (1) such sign shall be allowed per property per event;
- (ii) Such sign, if a ground sign, shall not exceed 60 inches in height measured from finished grade and 32 square feet in sign area per side;
- (iii) Such sign, if attached to a wall, shall not exceed 32 square feet in sign area; and
- (iv) Such sign shall be erected no sooner than five (5) thirty (30) days prior to the event and shall be removed within one (1) day following the event.

(i) Menu Board. Menu boards shall be allowed only as an accessory use to a restaurant permitted to have a drive-thru window under the Zoning Ordinance provided that:

- (i) Such sign shall not exceed 40 square feet in sign area and 72 inches in height measured from finished grade;
- (ii) Such sign shall not be legible or visible from the public right-of-way;
- (iii) There shall be no more than one (1) such sign per property;
- (iv) The color of such sign shall be neutral or earth tone and or have similar material treatments as the principal structure;
- (v) Such sign shall have placed around the back side evergreen shrubbery and trees sufficient to screen the sign from public view along the right-of-way;

## ORDINANCE 16-245

- (vi) Such sign may have changeable copy (manual and/or electronic); and
- (vii) Such sign may be internally or directly illuminated.
- (j) Model Home
  - (i) Such signs shall be limited to one (1) on any single-family parcel;
  - (ii) Such sign shall not exceed 72 inches in height measured from finished grade including a decorative cap;
  - (iii) The allowable sign area shall be 16 square feet and the sign shall not exceed 72 inches in height measured from finished grade;
  - (iv) The sign may be double-sided and shall be attached to two (2) separate decorative posts white in color located not more than 48 inches apart on center;
  - (v) Such sign shall not contain a commercial message;
  - (vi) Such sign shall be limited to four (4) colors including background color unless otherwise authorized by the Design Review Commission. The use of neon colors is prohibited.
  - (vii) The base of the sign shall be planted with evergreen shrubbery and seasonal colors in an area equivalent to the total sign area.

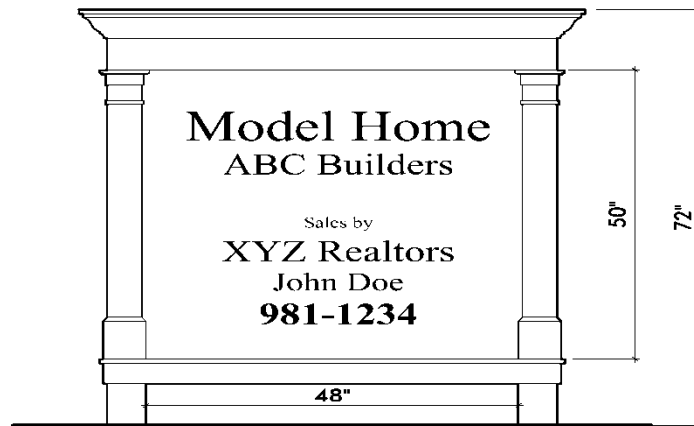

Figure 5: Model Home Sign

- (k) Political Sign. Political signs shall be allowed provided that:
  - (i) Such signs shall be limited to not more than one (1) per candidate or issue on any single occupied parcel except polling places on election day where signage may be placed in accordance with Election Commission guidelines for signage at polling places;
  - (ii) Such signs shall be located on private property, with permission of the property owner;
  - (iii) Such signs shall not be placed closer than fifteen (15) feet from the edge of pavement or five (5) feet behind a sidewalk, whichever is greater;

## ORDINANCE 16-245

(iv) Such signs shall not be erected or placed in such a manner that they interfere with, obstruct, or confuse or mislead vehicular or pedestrian traffic;

(v) No such sign shall be erected or displayed earlier than thirty (30) days before the election including Early Voting to which it relates, nor later than three (3) days following such election;

(vi) Such signs shall not be located in the public right-of-way or on other public property or on any public utility pole or tree, except within specified proximity of polling places on election day, under the rules established by the Shelby County Board of Election;

(vii) No signs will be allowed at polling places earlier than one (1) day before an election or early voting period and must be removed not later than one (1) day after said election or early voting period. For signs placed at polling places no permit or bond will be required, but requirements of all other sections of this Ordinance shall apply;

(viii) Such signs shall not exceed five (5) square feet in area per side and 48 inches in height;

(ix) Such signs erected or maintained not in accordance with the provisions of this subsection shall be the responsibility of the owner of the property upon which the sign is located, shall be deemed a public nuisance, and may be abated, without notice, by such property owner, the candidate, or person advocating the vote described in the sign, or the Code Enforcement Official or his/her designee;

(x) Any candidate or political committee desiring to distribute, cause to be distributed, display, place, or erect any political sign shall file an application for a Political Sign Distributor's Permit with the City of Lakeland upon forms furnished by the City, and provide such pertinent information as said application may require;

(xi) The Political Sign Distributor's Permit application shall include an agreement, which obligates the applicant to reimburse the City of Lakeland for costs associated with removal of signs specified in Section 14-404.2 (11) (a) through (h) of this Ordinance. Upon filing such application, the Code Enforcement Official or his designee shall issue a Political Sign Distributor's Permit to the applicant together with the issuance of a permit number; and,

(xii) Any person desiring to post or erect any political sign including but not limited to signs advertising a political party or the candidacy of any individual for any nomination or office, shall, in addition to obtaining the Political Sign Distributor's Permit required by Section 14-404.2 (11) (i) and (j) of this Ordinance, first deposit with the City of Lakeland a cash bond in the amount of five hundred dollars (\$500.00), which bond shall be conditioned upon removal of each and every such sign within five (5) days after the announced results of the nomination, election, or referendum to which the sign pertains. If such removal is not



ORDINANCE 16-245

made within the specified time, the bond shall be forfeited to the City of Lakeland, and may be used by the City to defray the cost of removing such signs.

(xiii) The City Manager may, at his discretion, establish a uniform policy whereby a specific portion of the bond is assessed per sign not removed within the specified time so that part but not necessarily all of the bond shall be forfeited, depending upon the number of signs per candidate City Staff is required to remove.

(l) Principal Ground Sign. Principal ground signs shall be allowed, provided that:

(i) Such signs shall not exceed 72 inches in height measured from finished grade;

(ii) Such signs shall not exceed 32 square feet in sign area per side;

(iii) Such signs shall be set back a minimum of 10 feet from the edge of the public street right-of-way;

(iv) Such signs shall be oriented to the middle of the front property line unless in conflict with an entrance but, in no case shall be placed within 15 feet of a side property line oriented perpendicular to the front property line;

(v) The base of the sign shall be landscaped with evergreen and deciduous shrubbery and seasonal colors on each side of the sign in an area equivalent to the total sign area of each face of the sign. All landscaping shall be irrigated.

(vi) Such signs may display not more than three (3) pieces of information including the street address of the property;

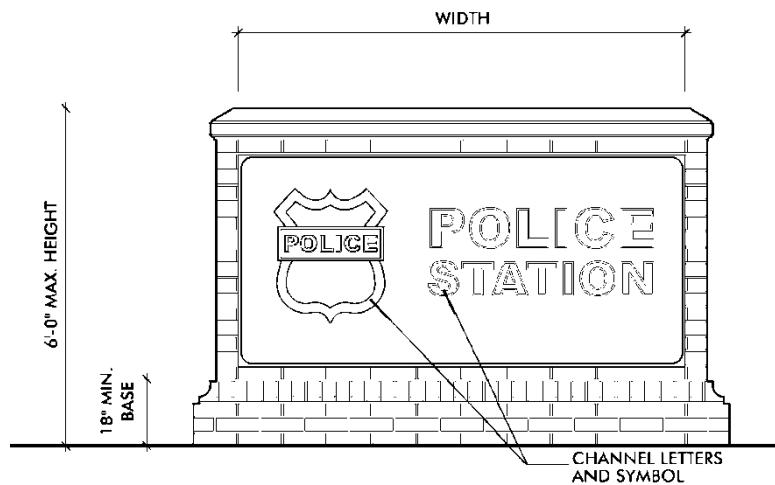

Figure 5: Principal Ground Sign

## ORDINANCE 16-245

(vii) Both sides of the two-side ground sign shall be identical in design and content;

(viii) The sign shall be placed upon a masonry base a minimum of 18 inches in height measured from finished grade;

(ix) A sign placed in a residential district shall not be internally illuminated. The sign may be illuminated using backlighted lettering or reverse channel lettering creating a halo-effect or direct lighting from a ground-mounted light fixture not to exceed 100 watts screened from public view with evergreen plant materials;

(x) For a single-occupant property, only one (1) principal ground sign shall be permitted unless otherwise provided in this Ordinance;

(xi) For a multi-occupant project, there shall be only one ground sign for the entire project plus one (1) additional principal ground sign for street frontage adjacent to a corner side yard on a secondary street, provided that the frontage on that street is at least 150 feet in length and that an actual entrance to the project is permitted and exists prior to installation of the sign and the secondary principal ground sign conforms to the area, height and location requirements of this ordinance for a Principal Ground Sign;

(xii) For a multi-occupant property, the principal ground sign shall contain only three (3) pieces of information including the street number and/or address and name of the development and shall not contain a commercial message; and

(xiii) Outparcels in shopping centers shall be permitted to have only one (1) principal ground sign OR one (1) wall sign (outparcels shall not be entitled to multiple signs) regardless of the number of property lines fronting upon a public street and shall be subject to the requirements for a principal ground sign for a single-occupant property unless otherwise provided in this Ordinance.

(m) Public Event Banner. Public event banners shall be allowed provided that:

(i) Such banners shall contain no commercial message;

(ii) Such banners shall not be attached to a light pole or other existing pole, without the express written permission of the owner of the pole;

(iii) Such banners shall be permitted only for public events proclaimed by the Board of Commissioners and then only for a period beginning not more than thirty (30) days prior to the event and ending not more than one (1) day after the conclusion of the event.

(n) Real Estate Sign, Except Single-family Residential. Real estate signs shall be allowed provided that:

## ORDINANCE 16-245

(i) On single-family residential lots, one (1) residential sign shall be permitted as more fully described in Item 15 below.

(ii) On multifamily residential projects and non-residential developments (i.e., commercial, office, industrial), one (1) real estate sign shall be permitted, provided that:

(A) Such sign shall not exceed 16 square feet per side in area and 72 inches in height measured from finished grade;

(B) There shall be not more than (1) real estate sign on any site except where the parcel has more than 1,000 linear feet of road frontage whereby one (1) additional sign may be placed a minimum distance of 500 feet from the other real estate sign;

(C) Such sign shall not be posted in public rights-of-way or on any private common area;

(D) Such signs shall be set back from the front property line a minimum of 20 feet;

(E) Such signs shall carry no commercial message other than information on the lease or sale of the premises on which the sign is displayed; and

(F) Such signs shall not advertise or identify the conducting of a permitted non-residential use.

(o) Residential Real Estate Sign, Single-family Residential.

Residential signs shall be allowed provided that:

(i) Such signs shall not exceed nine (9) square feet per side in area and 48 inches in height measured from finished grade;

(ii) There shall be not more than one (1) residential sign on any site containing only one dwelling unit;

(iii) Such signs shall not be posted in public rights-of-way or on any private common area;

(iv) Such signs shall be setback from the front property line facing the public right-of-way a minimum of 15 feet;

(v) Such signs shall carry no commercial message other than information on the lease or sale of the premises on which the sign is displayed; and,

(vi) Such signs shall not advertise or identify the conducting of a permitted home occupation in a residential district.

(p) Subdivision Entry Sign. Ground-mounted signs integrated into the entrance treatment (i.e., entrance wall) with the name of the subdivision or planned unit development may be allowed on one or both sides of each principal entrance. Subdivision entry signs shall be located on private property and shall not obstruct any public right-of-way or easement. Where located at the side of

ORDINANCE 16-245

the road on private property, there may be one (1) sign located on one side of the entrance road or on both sides of the entrance road at each principal entrance to the subdivision or planned unit development, provided that:

- (i) Such signs shall not exceed 32 square feet in sign area per entry sign;
- (ii) Such sign shall not exceed 72 inches in height measured from finished grade, unless integrated into a wall or column, in which case it shall not exceed the height of the wall or column; and
- (iii) Such sign shall contain no commercial message.

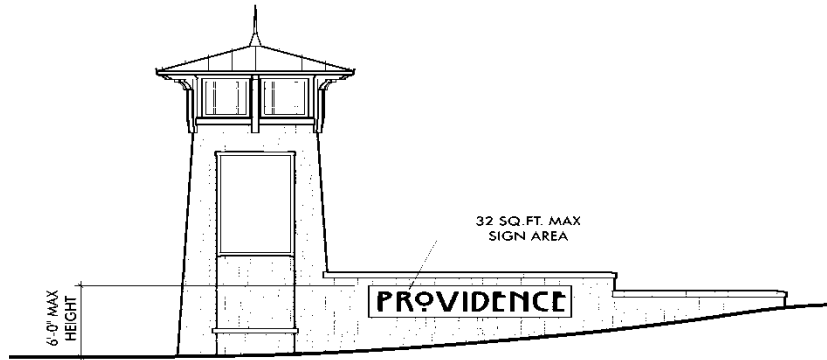

Figure 6: Subdivision Entrance Sign

(q) Temporary Signs. Signs for temporary uses, special events or the opening of businesses, as expressly permitted under this Ordinance, provided that:

- (i) Such signs shall not be located on public property;
  - (A) Such sign, if a ground-mounted sign, shall be placed a minimum of ~~ten (10)~~ ~~fifteen (15)~~ feet from the front property line and shall not be placed in such a manner as to obstruct visibility;
  - (B) Sign permits shall be limited to duration of thirty (30) days or, for a temporary use or for the period of time stated on the temporary use permit. **Permitted duration shall not to exceed 30 days in a calendar year;**
  - (C) No more than ~~six (6)~~ ~~one (1)~~ temporary sign permit shall be issued within a **calendar year** ~~12-month period~~ for the same business in the same location;
  - (D) Sign permits for new businesses shall be issued only upon the initial opening of a business for a period that shall end not later than thirty (30) days after issuance of the first business license for that business in that location. **New business temporary signs do not count towards the annual permit allotment specified in Section 17 (d) above;**

## ORDINANCE 16-245

(E) Temporary signs, when installed as a wall-mounted sign, shall be attached to and parallel with a wall of the building on which wall signs are permitted and shall not exceed thirty-two (32) square feet of surface area;

(F) Such signs may be made of cloth or canvas and are not subject to the construction and installation requirements otherwise applicable in this Ordinance;

(G) Where a temporary use permit specifically authorizes the use of the temporary ground sign, such sign, **except feather flags**, shall not exceed forty-eight (48) inches in height measured from finished grade. **and thirty-two (32) square feet in sign area per side.** Feather Flags shall not exceed eight (8) feet in height measured from finished grade. All temporary ground signs shall not exceed thirty-two (32) square feet in sign area per side;

(H) Temporary signs shall not require the review and approval of the Design Review Commission prior to issuance of a Sign Permit by the City of Lakeland;

(I) Supporting structures for temporary signs shall be removed when no temporary sign is present.

(J) For single occupancy buildings, temporary signs shall not be allowed if a permanent ground sign does not exist on the property.

(ii) Not-for-profit special events, such as those associated with a civic, philanthropic and educational purpose, shall be allowed a temporary sign, regardless of whether a temporary use permit is required and whether the use is specifically permitted under this Ordinance, provided that:

(A) Only one (1) such sign shall be allowed per property per event;

(B) Such sign shall be located only on private property or on the public property where the event will be held;

(C) Such sign, if a ground sign, shall be limited to 48 inches in height measured from finish grade and 32 square feet in sign area per side;

(D) Such sign, if attached to a wall, shall be limited to 32 square feet in sign area and securely attached on all corners;

(E) Such sign shall be erected no sooner than thirty (30) days preceding the event and shall be removed no later than one (1) day following the conclusion of the event; and,

(F) Temporary signs for non-profit special events shall not require the review and approval of the Design Review

## ORDINANCE 16-245

Commission prior to issuance of a Sign Permit by the City of Lakeland.

(r) Wall Sign, Nonresidential. Wall signs shall be allowed on nonresidential properties that are proportionate to the scale and massing of the building upon which the sign is attached, provided that:

(i) The total area of all wall signs on a building shall not exceed one square foot in area for each linear foot of building frontage; provided, however, that in the case of a primary building or structure located more than 100 feet from the front property line the Design Review Commission may allow an increase in the permitted sign area at a ratio equivalent to the total distance of the primary building from the front property line divided by 100 for each linear foot of building frontage not to exceed a maximum of one and one half (1.5) square feet in area for each one (1) linear foot of building frontage unless otherwise restricted. For example, a building located 138 feet from the front property line may be permitted to have a ratio of 1.38 square feet of sign area for each linear foot of building frontage.

In the case of a single occupant building that is also permitted to have one or more principal ground signs, the total area of all wall signs on a building shall not exceed one-half square foot in sign area for each linear foot of building frontage regardless of the distance from the building or structure to the front property line; provided, however, the Design Review Commission may allow an increase in allowable sign area in consideration of scale and massing of front façade, not to exceed a maximum of one (1) square foot in sign area for each one (1) linear foot of building frontage.

~~(ii) A wall sign shall not exceed a maximum sign area of 50 square feet unless otherwise provided in this Ordinance;~~

(iii) The total area of all wall signs on a particular wall or a section of wall shall not exceed the wall sign area as prescribed elsewhere in this Ordinance;

(iv) Such signs shall be located only on principal buildings and shall not be placed on accessory buildings;

(v) No wall sign shall project above the highest point of the building wall on the same side of the building as the sign;



Figure 7 Wall Sign, Non-Residential

(vi) On a single occupancy building, all signage or message elements, except for poster boxes, logos, and wall signs on theaters on any single wall, shall be considered parts of the same sign and shall be measured as prescribed elsewhere in this Ordinance;

(vii) A single-occupant building shall be limited to one (1) wall sign unless otherwise provided in this Ordinance;

(viii) A single-occupant building shall be limited to one (1) wall sign installed facing a public right-of-way unless otherwise provided in this Ordinance;

~~(ix)~~ A single-occupant building located on a lot with multiple frontage upon a public right-of-way may be permitted to have one (1) wall sign installed facing each public right-of-way **not to exceed a total of two (2) wall signs for the entire building;**

(x) On a multi-occupant building except for multi-tenant convenience centers as provided for in Section 14-404.2 (21) of this Ordinance, each occupant with a primary outside entrance serving the general public may have one (1) wall sign. Corner tenants with a separate outside entrance serving the general public as a point of ingress and egress that is on a different exterior wall from the primary entrance for which the tenant space is accessed may be allowed one (1) additional wall sign centered over the secondary entrance subject to review and approval by the Design Review Commission;

(xi) On a multi-occupancy building serving primarily office uses, there may be signs on only one (1) wall of the building; provided, however, that in the case of **shopping mall multiple occupancy building** containing more than 150,000 square feet of gross floor area and more than seven (7) tenants facing upon a public right-of-way, tenants

ORDINANCE 16-245

within the shopping mall multiple occupancy building may be permitted subject to approval of the Design Review Commission to have one (1) exterior wall sign not to exceed 50 square feet of sign area to be installed on the exterior wall of the shopping mall multiple occupancy building;

(xii) Conditions above shall not apply to changeable copy signs for a convenience store vending gasoline products or a theater, which shall be subject to the requirements of Item 2, above;

(xiii) Multi-occupant buildings containing more than one tenant wall sign shall have a sign policy that outlines the colors, font, illumination, size and location of all wall-mounted signs. Wall signage should complement the Principal Ground Sign.

(s) Wall Sign, Residential/Institutional

(i) Single-family residential units (either attached or detached) including permitted professional home occupations in residential zoning districts or planned unit developments designated for such use shall be permitted one (1) wall sign, provided that:

- (A) Such sign shall not exceed two (2) square feet in sign area;
- (B) Such sign shall not be separately illuminated; and
- (C) Such sign shall not contain any commercial message.

(ii) Institutional uses located in residential zoning districts and planned unit developments designated for such use, shall be permitted one (1) wall sign per public entrance, provided that:

- (A) Such sign shall not exceed three (3) square feet in sign area;

and,

(B) Each sign may be illuminated only by direct external illumination.

~~(t) Yard Sale Sign. Signs for yard sales shall be allowed provided that:~~

~~(i) Only one (1) such sign shall be on the lot where the yard sale is located;~~

~~(ii) Such sign shall not exceed five (5) square feet in sign area per side and 48 inches in height measured from finished grade;~~

~~(iii) Such sign shall be removed immediately upon conclusion of the yard sale;~~

~~(iv) No such signs shall be placed in such a manner as to obstruct visibility or be attached to utility poles, directional or regulatory signage, or trees; and~~

~~(v) Such sign shall not be placed closer than 15 feet from the edge of pavement or five (5) feet behind a sidewalk, whichever is greater.~~

(u) Gasoline Trade Signs. Petroleum product pumps and dispensers that are within view of the public right-of-way shall be permitted to display only



## ORDINANCE 16-245

that information required by law along with brand name and type of product being dispensed. No other advertising shall be displayed on the pumps, temporary or permanent.

(i) Principal Ground Sign. Premises that dispense retail bulk petroleum products by pump shall be allowed to display the changeable copy pricing of such products within a single principal ground sign or wall sign. The principal ground sign may also contain the name and/or logo of the principal tenant; provided, however, said principal ground sign or wall sign shall conform to the design requirements contained in Table 2 of this Ordinance (see Section 14-404.3).

(ii) Canopy Sign. When an enclosed principal structure exists, all canopy signs shall be calculated and deducted from the total allowable wall sign area. In the absence of an enclosed principal structure, for the purposes of this subsection, canopy signage may be allowed in addition to the permitted principle ground sign. With the exception of the measurable area for placement of the canopy sign, no internally illuminated or back lighting of the outside canopy area or canopy roofline shall be permitted. Only one (1) canopy sign not exceeding a total sign area of ten (10) square feet shall be permitted on one (1) canopy façade regardless of the number of streets the property fronts.

(iii) Gasoline Pump Identification Sign. For the purpose of identifying the brand of gasoline, each pump shall be allowed one sign not to exceed one (1) square foot mounted on the pump facade. No other commercial message shall be displayed.

(iv) Multiple-tenant Convenience Centers. For the purpose of identifying multiple tenants within a Convenience Center, the Principal Ground Sign or Wall Sign may be divided equally among those tenants occupying the Convenience Center; provided, however, said principal ground sign shall conform to the design requirements contained in Table 2 of this Ordinance.

ORDINANCE 16-245

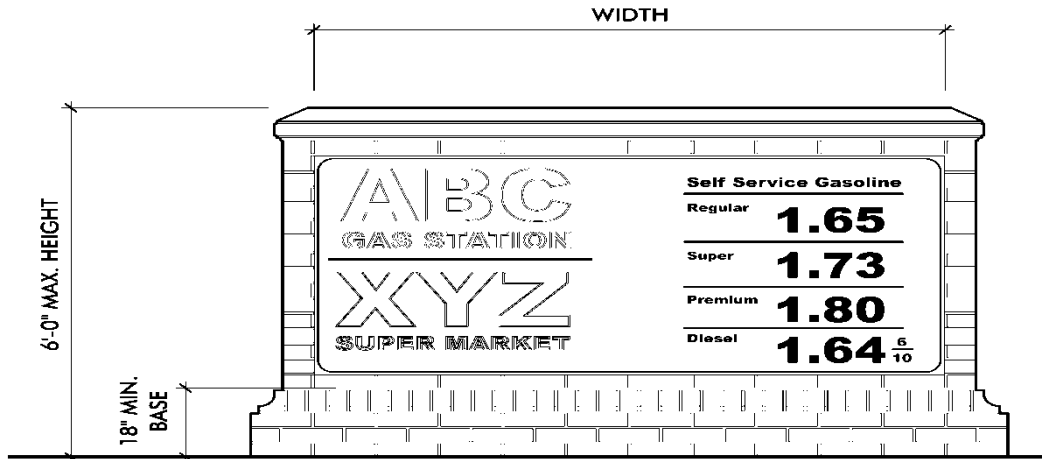

Figure 8: Multi-tenant Convenience Store Sign

(w) Subdivision Development Sign:

(i) Such signs shall be limited to one (1) located within 100 feet of the primary entrance to the subdivision provided the sign must be located on property located within the subdivision.

(ii) Such sign shall not exceed 72 inches in height measured from finished grade including a decorative cap.

(iii) The allowable sign area shall be 24 square feet and the sign shall not exceed 72 inches in height measured from finished grade.

(iv) The sign may be double-sided and shall be attached to two (2) separate decorative posts white in color located not more than 48 inches apart on center.

(v) Such sign shall not contain a commercial message.

~~(vi) The background color shall be white and all other lettering and logos/trademarks shall be limited to three (3) colors.~~

(vii) The base of the sign shall be planted with evergreen shrubbery and seasonal colors in an area equivalent to the total sign area.

(viii) The sign shall be removed upon development of ninety percent (90%) of available lots in the subdivision.

## ORDINANCE 16-245



Figure 9: Subdivision Development Sign

(x) Yard of the Month Signs Temporary Residential Yard Signs. Signs shall be permitted, provided that such signs do not exceed five (5) square feet in surface area and 48 inches in height measured from finished grade. Yard of the Month Signs shall be set back from the public right-of-way a minimum of fifteen (15) feet.

(y) Street Numbers. All occupied buildings and/or structures shall have prominently displayed on the front façade near the primary entrance or upon the principal ground sign, the street number assigned to the building and/or structure so as to be readily identified by emergency response personnel. If mounted to a wall, street number signs shall not be calculated as part of the total allowable sign area for a wall sign. Street numbers shall not exceed 10 inches in height unless otherwise required by fire safety regulations.

(z) Suspended Sign (Planned Commercial). Suspended signs shall be allowed under canopies provided that:

- (i) Such sign shall not exceed one per building or tenant entrance;
- (ii) Such signs shall not exceed three (3) square feet in sign area;
- (iii) Such signs shall not be separately illuminated; and,
- (iv) Such signs shall contain only the two (2) pieces of information excluding the street number or suite number of the occupant served by the entrance.

(aa) Shopping Center Signs

- (i) Qualifying Sites - Shopping Center Signs may be permitted on commercial sites that meet all of the following criteria:

## ORDINANCE 16-245

(A) The property upon which the sign would be located is zoned C-2.

(B) The commercial project is located directly adjacent to Canada Road, Highway 64, or Highway 70.

(C) The project contains at least 20,000 sq. ft. of leasable area.

(D) The project contains at least eight (8) tenant spaces.

(ii) Standards. If a property qualifies for a shopping center sign, the following standards shall apply:

(A) A maximum of one shopping center sign shall be allowed per street frontage and shall be located only on an arterial road (Canada Road, Highway 64, or Highway 70).

(B) The maximum total sign area shall be 150 square feet

(C) The maximum size of the directory space shall be 120 square feet.

(D) The maximum height of the sign shall not exceed 15 feet.

(E) The maximum width of the sign face shall be 10 feet

(F) The maximum individual tenant space on the sign shall be 15 square feet.

(G) The minimum letter height allowed for tenant identification on the sign shall be 10 inches.

(H) The minimum setback from right-of-way is 10 feet.

(I) No shopping center sign shall be located within 500 feet of another shopping center sign.

(J) The shopping center sign shall include the street address of the center, or the address range if more than one address is included in the project.

(K) The sign shall be placed upon a brick or stone base a minimum of 18 inches in height measured from finished grade.

(L) The base of the sign shall be landscaped with evergreen and deciduous shrubbery and seasonal colors on each side of the sign in at least an area equivalent to the total sign area of each face of the sign.

(M) No Sign within six hundred (600) feet of any residential District shall be illuminated between the hours of midnight and 6:00 a.m. unless the sign is visibly obstructed from the residential District.

ORDINANCE 16-245

(3) **Freestanding Sign Height, Maximum Sign Area and Minimum Setback Requirements.** The freestanding sign height, maximum sign area, and minimum setback from street rights-of-way for each type of sign permitted by this Ordinance shall be as provided for in Table 2 below:

**Table 2: Freestanding Sign Height, Maximum Sign Area and Minimum Setback from R. O. W.**

Sign Type	Residential Districts	Commercial Districts	Industrial District	Planned Developments	Conditions
Changeable Copy	72/32/20	72/32/20	72/32/20	72/32/20	2
Construction	48/16/20	48/16/20	48/16/20	48/16/20	3
Directory, Logo/Name	---	48/16/100	48/16/100	48/16/100	4
Incidental	24/1/10	24/1/10	24/1/10	24/1/10	7
Institutional	60/32/20	60/32/20	60/32/20	60/32/20	8
Menu Board	---	72/40/*	---	72/40/*	9
Model Home	72/16/15	---	---	72/16/15	10
Political	48/5/15	48/5/15	48/5/15	48/5/15	11
Principal Ground	72/32/20	72/32/20	72/32/20	72/32/20	12
Real Estate	72/16/20	72/16/20	72/16/20	72/16/20	14
Residential Real Estate	48/9/15	48/9/15	48/9/15	48/9/15	15
Subdivision Development	72/24/15	72/24/15	---	72/24/15	22
Subdivision Entry	72/32/---	72/32/---	72/32/---	72/32/---	16
Temporary	48/16/20	48/16/20	48/16/20	48/16/20	17
Yard Sale	48/5/15	48/5/15	---	48/5/15	20
Yard-of-the-Month	48/5/15	48/5/15	---	48/5/15	23
Interstate	---	**	---	**	See Section 14-407.1
Highway 64 Corridor	---	**	---	**	See Section 14-407.2

99/99/99 - Freestanding sign height in inches/ maximum sign copy area in square feet/ minimum setback from edge of public street Right of Way in feet

\* - Menu board signs are allowed only in the rear yard and shall be screened from public view with sufficient landscaping materials.

\*\* - See Section 14-407 of this Ordinance for specific design standards.

## ORDINANCE 16-245

### 14-405 Prohibited Signs and Devices.

All signs not expressly permitted under this Ordinance or exempt from regulation as provided for in this Ordinance are prohibited. Such signs include, but are not limited to:

- (1) Signs which are of a size, location, movement, content, coloring, or manner or illumination which may be confused with or construed as a traffic control device or which hide from view any traffic or street sign or signal;
- (2) Signs which contain or are an imitation of an official traffic sign or signal or contain the words "Stop," "go slow," "Caution," "Yield," "danger," "Warning" or similar words;
- (3) Signs which show pictures of human figures, animals or food, and signs which contain characters, cartoons or statements of an obscene, indecent or immoral character which would offend public morals or decency;
- (4) Signs which are of a size, location, movement, content, coloring, or manner or illumination which may be confused with or construed as a traffic control device or which hide from view any traffic or street sign or signal;
- (5) Signs which purport to be, or are an imitation of, or resemble an official traffic sign or signal;
- (6) Changeable copy signs (manual and automatic), except for civic, institutional and schools. Any changeable copy sign (manual) that does not have a locked, vandal-proof access cover;
- (7) Canopies with backlighting shall not be allowed;
- (8) Any internally illuminated sign, unless permitted in a commercial district;
- (9) Beacons;
- (10) Rotating signs;
- (11) Snipe signs, or off-premise signs attached to utility poles, trees, or any like freestanding structure;
- (12) Windblown devices;
- (13) Flashing signs;
- (14) Open channel letter signs;
- ~~(15)~~ Pennants;
- (16) Projecting signs;
- (17) Canopy signs;
- (18) Marquee signs;
- (19) Tag signs;
- (20) Portable signs;
- (21) Double-faced, "V"-type back-to-back signs;

## ORDINANCE 16-245

- (22) Pole signs;
- (23) Project signs;
- (24) Inflatable signs;
- (25) Signs painted on or attached to balloons and other such devices, whether hot air or cold air or gas filed;
- ~~(26) Window signs~~
- (27) Animated signs;
- (28) Signs which emit audible sound, odor or visible matter;
- (29) Off-premise signs;
- (30) Any commercial sign located in a residential district not otherwise provided for in this Ordinance;
- (31) Strips or strings of lights outlining property lines, sales areas, roof lines, doors, window, wall edges, or other architectural elements of a building, provided, however, this prohibition shall not apply generally to holiday decorations and lighting;
- (32) Neon and other similar type signs located in such a manner as to attract public attention from outside the building that: (a) contain a message clearly intended for public recognition outside the buildings such as “drive thru” and other similar messages; or (b) are legible from the public right-of-way or adjacent property; provided, however, ~~a neon~~ **an illuminated** sign containing the word “Open” may be displayed in the front window of a tenant space provided such sign does not exceed four (4) square feet in sign area and must be turned off **after business hours or when the tenant space is not being occupied;**
- (33) Signs attached to, suspended from or painted on any vehicle which is regularly parked on any street or private property when one of the purposes of so locating such vehicle is to display, demonstrate, and advertise or attract the attention of the public:
  - (a) It is not a violation of this section merely to have a common logo of business sign attached to, suspended from, or painted on a company vehicle regularly engaged in the business of the owner, and;
  - (b) When appropriate authorities determine that a vehicle is being regularly parked in a manner that violates this chapter, the City will issue a single notice of violation to the owner of the vehicle, to remove said vehicle from the premises. Failure to remove said vehicle might result in further legal action including the removal of said vehicle by the City.
- (34) Any sign attached to an accessory structure, except an incidental sign, if such sign is legible from the public right-of-way or from an adjoining property;
- (35) Signs which are structurally unsound or which are rendered structurally sound by guy wires or unapproved facing or bracing;
- (36) Abandoned, neglected or dilapidated signs;

## ORDINANCE 16-245

- (37) Any other attention-attracting device, except for those conforming to the dimensional, design, lighting and other standards applicable to a sign in the same location;
- (38) Any sign that obstructs or substantially interferes with any window, door, fire escape, stairway, ladder, or opening intended to provide light, air, ingress, or egress to any building;
- (39) Ground signs exceeding 32 square feet in copy area and/or signs and sign structures in excess of 72 inches in height unless otherwise provided for in this Ordinance;
- (40) Signs in any area designated as an undisturbed buffer pursuant to a federal, state or local law, pursuant to a condition of approval for a subdivision, planned development or site plan;
- (41) Signs which advertise an activity illegal under federal laws, the laws of the State of Tennessee, or any laws of Shelby County or the City of Lakeland; and
- (42) Any sign that exhibits statements, words or pictures of an obscene nature.
- (43) Signs not expressly permitted in this Ordinance are prohibited.

### **14-406 Design and Construction Standards**

**(1) Construction Standards.** All signs shall be designed, constructed and maintained in accordance with the following standards:

(a) All signs shall comply with applicable provisions of local, state and federal building codes including seismic design standards and wind load design specifications.

(b) Electrical signs that have internal wiring or lighting equipment, and external lighting equipment that directs light on signs, shall not be erected or installed until an electrical permit has been obtained from the City or authority having jurisdiction. All such signs and equipment shall bear the seal of approval of an electrical testing laboratory that is nationally recognized as having the facilities for testing and requires proper installation in accordance with the National Electrical Code. All wiring to electrical signs or to freestanding equipment that lights the sign shall be installed underground.

(c) Except for permitted banners, flags, temporary signs and window signs conforming in all respects with the requirements of this Ordinance, all signs shall be constructed of permanent materials and shall be attached to the ground, a building or another structure by direct attachment to the wall, frame or structure.

(d) All ground-mounted signage shall include landscaping around the entire base of the sign structure. Landscaping shall consist of multiple rows of evergreen and deciduous plant materials and seasonal colors that add visual interest to the sign. All landscaping shall be irrigated. All plant materials shall be properly maintained including the immediate removal and replacement of any dead or diseased plant materials.



## ORDINANCE 16-245

(2) **Maintenance Standards.** All signs shall be maintained in good structural condition, in compliance with all building and electrical codes, and in conformance with this Ordinance. Specifically:

(a) A sign shall have no more than 20 percent of its surface area covered with disfigured, cracked, ripped or peeling paint, poster paper or other material for a period of more than 30 days.

(b) A sign shall not stand with bent or broken sign facing, with broken supports, with loose appendages or struts, or more than 15 degrees from vertical for a period of more than ten (10) days.

(c) A sign shall not have weeds, trees, vines, or other vegetation growing upon it, or obscuring the view of the sign from the public right-of-way from which it is to be viewed, for a period of more than 15 days.

(d) An internally illuminated sign shall be allowed to stand with only partial illumination for a period of no more than 15 days.

(e) Flags shall not be faded, tattered or torn.

(f) All landscaping installed around the base of a sign shall be maintained whereby any dead plant materials are replaced with the same plant material in a size and spread comparable to other plant materials installed around the base of the sign at the time the replacement plant materials are being installed.

(3) **Signs not to Create Traffic Hazard.**

(a) Clear Sight Triangle. All entrance signs and freestanding signs located near the corners of an intersection shall be located outside of the clear sight triangle. Such triangle shall be measured at a distance of 35 feet running parallel along each leg of the road or driveway pavement surface and connecting them to form a triangle area. This area shall be free of any permanent or temporary signs that may inhibit clear sight visibility for motorists and/or pedestrians.

(b) Other Hazards. No signs shall be erected, and there shall be no lighting of signs or premises, in such a manner or in such location as to obstruct the view of, or be confused with, any authorized traffic signal, notice or control device.

(c) Removal. Any such signs or light sources shall be removed at the direction of the City. If not removed by owners or occupants of the property within ten (10) days of notice, the City shall cause the signs to be otherwise removed, and the cost of removal including all incidental administrative costs shall become a lien against the property until satisfied.

(4) **Colors.** Signs that are internally illuminated shall not use more than three (3) colors, plus a background color, **as unless** specified in an approved Sign Plan. The background color shall be non-illuminated. Signs externally illuminated may upon approval of the Design Review Commission have up to five (5) colors excluding the background color. For panel signs, the background color shall mean the panel itself. For

## ORDINANCE 16-245

channel letters, the background color shall mean the returns. If the portion of the building wall behind a wall sign is painted a different color than the remainder of the wall, then such portion of the wall shall be counted as a background color. Trim colors shall be counted as background colors.

(5) **Display of Logos and Trademarks, General.** Logos and trademarks may be included on signs (except identification, residential and incidental signs) without separate restriction, provided that such logos and trademarks are consistent with the approved color scheme shown on the approved Sign Plan.

(6) **Display of Registered Trademarks.** A federally registered trademark which is registered in colors inconsistent with the applicable Sign Plan ~~or the color limitations applicable to a single occupancy property may nevertheless~~ be displayed in whole or part on a sign in its registered form and color(s), provided that it may only occupy up to twenty-five percent (25%) of the permitted area of the sign as permitted by the Design Review Commission, without regard to the color limitations otherwise applicable to the sign; placement on the sign shall be in accordance with any applicable provisions of the approved Sign Plan and as may be required by the Design Review Commission.

~~(7) **Logos as Pieces of Information.** A logo or trademark shall be considered one "piece of information" on a sign on which the number of pieces of information is limited.~~

(8) **Lighting.** Sign illumination shall only be achieved through the following standards:

(a) A white, steady, stationary light of reasonable intensity that is directed solely at the sign. The light source shall be shielded from adjacent buildings and streets, and shall not be of sufficient brightness to cause glare or other nuisances to adjacent land uses.

(b) Internal illumination shall provide steady, stationary lighting through translucent materials. The use of translucent backgrounds is not permitted. Backgrounds shall be opaque and not permit the transmission of light through the sign face material. Illumination of a logo or trademark may be permitted provided translucent backgrounds are not utilized.

(c) If the wall sign is internally illuminated or back lit by any means, the entire light area shall be included within the allowable signage calculation for the site.

(d) The light from any illuminated sign shall not be of an intensity or brightness that will interfere with the peace, comfort, convenience, and general welfare of residents or occupants of adjacent properties.

(e) No sign shall have blinking, flashing, or fluctuating lights or other illuminating devices that have a changing light intensity, brightness, or color.

(f) Exposed bulbs shall not be used on the exterior surface of any sign.

(g) Exposed neon shall not be allowed including use as an architectural detail element.

## ORDINANCE 16-245

(h) All wall signs shall be either individual translucent letters and an individual logo or reverse channel letters and individual logo with a backlit light source.

(i) No color lights shall be used at any location or in any manner so as to be confused with or construed as traffic control devices.

(j) Neither direct nor reflected light from primary light sources shall create a hazard to operators of motor vehicles.

(k) All electrical service to ground mounted signs shall be placed underground. Electrical service to other signs including wall signs shall be concealed from public view.

(l) A sign placed in a residential district shall not be internally illuminated. The sign may be illuminated using back lighting or reverse channel letters which create a halo-effect or ground-mounted direct light fixture not to exceed 100 watts and properly screened from public view with evergreen plant materials.

### (9) Signs in Public Right-of-Way.

(a) Permanent Signs. Permanent signs shall be limited to:

(i) Public signs erected by or on behalf of a governmental body to identify public property, convey public information and direct or regulate pedestrian or vehicular traffic;

(ii) Bus stop signs erected by a public transit company;

(iii) Informational signs of a public utility regarding its poles, lines, pipes or other facilities;

(iv) Signs appurtenant to a use of public property permitted under a franchise or lease agreement with the City; and

(v) Signs posted in association with municipal, county, state or federal authorities for crime prevention and public safety and health.

(b) Temporary Signs

(i) Legal notices erected by or on behalf of a governmental body;

(ii) Emergency warning signs or devices erected by a governmental agency, a public utility company, or a contractor doing authorized or permitted work within the public right-of-way.

(c) Subdivision and Neighborhood Identification Signs. Ground-mounted signs integrated into entrance treatment with the name of the residential or non-residential subdivision or planned unit development may be located on one or both sides of each principal roadway entrance into the development provided that:

(i) Roadside – One sign located on one side of the entrance road or on both sides of the entrance road at each principal entrance to the subdivision or planned unit development, provided that:

ORDINANCE 16-245

- (A) Such sign shall not exceed 32 square feet in area; and,
- (B) Such sign shall not exceed 72 inches in height, unless such sign is integrated into a wall or column, in which case such sign shall not exceed the height of the wall or column; and,
- (C) Such sign shall not contain a commercial message.

(d) Other Signs in Public Right-of-Way. Any other sign placed in the public right-of-way in violation of this Ordinance shall be deemed a public nuisance and may be seized by the enforcement official or other representative of the City, and the person owning or placing the sign may be charged both with a violation of this Ordinance and with the cost of removing and disposing of the sign.

14-407. Interstate and Highway 64 Corridor Signs

(1) Interstate Signage. The following signs shall be permitted on a parcel that is zoned C2, General Commercial and located within the Interstate Sign Zone contains a minimum lot frontage of one thousand (1,000) linear feet directly adjoins the right-of-way of Interstate 40:

(a) One (1) principal ground sign in conformance with 14-404.2 (12) of this Ordinance with the following exceptions

(i) The principal ground sign may contain up to one hundred (100) square feet in area; and,

(ii) The principal ground sign may be up to twenty (20) feet in height.

(b) One (1) wall sign in conformance with 14-404.2 (18) of this Ordinance;

One (1) monument-style interstate sign as follows provided that:

(a) The parcel on which the sign will be placed shall be zoned C-2, General Commercial District, and also shall have a minimum linear lot frontage of one thousand (1,000) linear feet directly adjoining the right-of-way of Interstate 40 (no exceptions).

(b) The monument-style interstate sign shall contain a solid base and shall be solid monument-style or a minimum of two (2) architecturally detailed columns of similar material to the base of the sign as approved by the Design Review Commission. No exposed posts or poles shall be permitted. The materials should match and/or compliment the materials, colors, and textures of the principal structure on the subject parcel.

(c) The monument-style interstate sign shall be placed in the middle third of the frontage directly abutting Interstate 40 unless otherwise authorized by the Design Review Commission to be placed on a property not facing the Interstate.

## ORDINANCE 16-245

- (d) The height shall not exceed 35 feet measured from the finished grade to the uppermost element of the sign structure.
- (e) The maximum sign area per sign face shall not exceed one hundred (100) square feet.
- (f) The sign face shall be limited to three (3) colors excluding the background color if internally illuminated. The Design Review Commission may allow the sign face to exceed three (3) colors excluding the background color if non-internally illuminated not to exceed a maximum of five (5) colors excluding background color.
- (g) The sign may be internally illuminated provided the background color shall be opaque and not be permitted to transmit light through the material.
- (h) The sign shall be limited to two (2) pieces of information. Both sign faces shall contain the same pieces of information.
- (i) Multiple-tenant occupancies shall not be permitted to have multiple-tenant signage (i.e., the principal tenant or the shopping center shall be the only tenant permitted to have a sign even if a multiple tenant occupancy exists).
- (j) The sign shall be positioned in the yard facing the right-of-way of Interstate 40 and shall be no closer than fifty (50) feet from the property line abutting the Interstate right-of-way.
- (k) The base surrounding the sign shall be landscaped an area equal to the total sign area and shall consist of a combination of evergreen and deciduous plant materials including trees and shrubs. All landscaping shall be irrigated. Any dead or diseased plant materials shall be replaced immediately.

### ~~(2) Highway 64 Corridor Signs.~~

~~(a) All parcels zoned commercial within the HWY 64 Sign Zone having direct frontage upon Highway 64 may be permitted the following exception to the requirements for a principal ground sign:~~

- ~~(i) One (1) principal ground sign not to exceed 72 inches twelve (12) feet in height measured from finished grade;~~
- ~~(ii) Such signs shall not exceed 32 sixty (60) square feet in sign area per side;~~
- ~~(iii) Such signs shall be set back a minimum of ten (10) 15 feet from the edge of the public street right of way;~~
- ~~(iv) Such signs shall be oriented to the middle of the front property line unless in conflict with an entrance but, in no case shall be placed within 30 feet of a side property line oriented perpendicular to the front property line unless otherwise approve by the DRC if site conditions warrant a different location;~~
- ~~(v) The sign shall be placed upon a masonry base a minimum of 18 inches in height measured from finished grade;~~
- ~~(vi) The base of the sign shall be landscaped with evergreen and deciduous shrubbery and trees and seasonal colors on each side of the~~

## ORDINANCE 16-245

sign in an area equivalent to the total sign area of each face of the sign. All landscaping shall be irrigated;

(vii) Such signs may display not more than two (2) pieces of information including the street address of the property;

(viii) Both sides of the two-sided ground sign shall be identical in design and content;

(ix) For a single-occupant property, there shall be only one (1) principal ground sign allowed;

(x) For a single-occupant property, one (1) wall sign installed in accordance with applicable design criteria for a wall sign shall be permitted in addition to the principal ground sign; and,

(xi) For a multi-occupant project, there shall be only one ground sign for the entire project unless the project has frontage upon a secondary street whereby one (1) additional standard principal ground sign may be permitted. The secondary street must provide a minimum of 150 linear feet of frontage upon the secondary street and an actual entrance must be constructed along the secondary street frontage serving the development. The secondary principal ground sign shall not exceed 72 inches in height and shall not contain more than 32 square feet of sign area and shall not be placed closer than 20 feet from the edge of the public right of way.

### 14-408 Administration and Penalties

(1) **Scope of Authority of Design Review Commission.** The Design Review Commission shall not have the authority to alter or amend this Ordinance nor to approve a sign not in conformity herewith except as provided in Section 14-410 of this Ordinance and is directed to cooperate with the Code Enforcement Official in the enforcement of same, including but not limited to, the following functions:

(a) The Design Review Commission, upon approving a sign, shall forward the application to the Code Enforcement Official with approval noted thereon.

(b) The Design Review Commission shall identify signs that it believes to be illegal, variance, and/or non-conforming signs to the Code Enforcement Official for enforcement.

(c) The Design Review Commission may take other action within its authority to insure safety, eliminate hazards, and eliminate encroachment upon public streets and property and encroachment upon adjoining land or users.

(d) The Design Review Commission, while it may not approve signs in violation of this Ordinance, has the specific and general authority to refuse approval of signs, otherwise in compliance with this Ordinance, which because of unsafe location, unsafe construction, aesthetic deficiency, insufficient structure and/or encroachment upon surrounding property, violate the spirit of this Ordinance, which is dedicated to the safety and public welfare of all citizens and businesses in the City of Lakeland.

(e) The Design Review Commission shall not review

## ORDINANCE 16-245

- i. Applications and related documents for Temporary Signs;
- or,
- ii. Individual signs that are a part of a previously approved site plan; or
- iii. Wall signs that are in compliance with all aspects of the sign ordinance.

(2) **Authorization to Enforce Sign Ordinance.** The Code Enforcement Official is hereby authorized and directed to enforce all of the provisions of this Ordinance. Upon presentation of proper credentials, the Code Enforcement Official, or his duly authorized representative, shall be permitted by the owner or occupant to enter at reasonable times, any building, structure or premises in the City of Lakeland to perform any duty imposed upon him by this Ordinance.

(3) **Appeal.**

(a) Appeal from Decision of the Code Enforcement Official.

(i) Any applicant aggrieved by any decision or order of the Code Enforcement Official may appeal, within a period not to exceed ten (10) days from said action, to the Design Review Commission by serving written notice to the City Clerk Recorder who, in turn shall immediately transmit the notice to the Design Review Commission which shall meet to hear said appeal within thirty (30) days thereafter.

(ii) If the Design Review Commission should fail to hear the appeal within thirty (30) days, the appeal shall be referred directly to the Board of Commissioners.

(iii) The Code Enforcement Official shall take no further action on the matter pending the Design Review Commission's decision, except from unsafe signs that present an immediate and serious danger to the public, as provided elsewhere in this Ordinance.

(b) Appeal from Decision of Design and Review Commission.

(i) The decision of the Design Review Commission may be appealed directly to the Board of Commissioners upon written notice of appeal to the Board within five (5) days of said action.

(ii) The appeal shall be heard at a scheduled meeting of the Board of Commissioners.

(iii) The Board of Commissioners may accept, reject or modify the action of the Design and Review Commission.

(iv) Any action on an appeal from the Design Review Commission shall require a minimum of four (4) affirmative votes of the Board of Commissioners and in the absence thereof, the action of the Design Review Commission shall become final and binding.

(4) **Penalties.** Any person, firm or corporation violating any of the provisions of this Ordinance shall be deemed guilty of a misdemeanor, and upon conviction thereof,



## ORDINANCE 16-245

shall be fined not more than the maximum allowable fine under State law, each day's continuance of a violation constituting a separate offense. The owner of any sign, building, premises, or part thereof, where a sign in violation of this Ordinance shall be placed, or shall exist, and any person who may have assisted in the commission of any such violation, shall be guilty as an accessory of the offense.

### 14-409 Permits and Fees

#### (1) Permits Required for Signs.

(a) All permanent and temporary signs allowed under this Ordinance, including existing signs, shall require a permit unless provided otherwise in this Ordinance.

(b) No sign shall be placed, constructed, erected, altered or relocated on a site without a permit, except as otherwise provided herein. Required electrical permits shall be obtained at the same time the Sign Permit is obtained by the applicant.

(c) With the exception of signs that comply with a sign plan contained within an approved Planned Unit Development (provided such plan was approved prior to June 27, 2003 Month, date, year), no sign permit of any kind shall be issued for an existing or proposed sign unless such sign is consistent with:

(i) Any Sign Plan approved and in effect for the property; and,

(ii) The conditions of this Ordinance.

(d) No permit shall be issued for a permanent sign requiring a sign permit until the application has received the review and approval of the Design Review Commission as provided for in this Ordinance.

(e) Where there is a conflict between the Ordinance and a Sign Plan, the Ordinance shall control. Any sign standard not included in a sign plan will be controlled by the sign ordinance.

#### (2) Application Requirements.

(a) An application for a sign permit may be filed only by the owner of the property on which the sign is to be erected, or by an agent, lessee, or contract purchaser specifically authorized by the owner to file such application. Where an agent, lessee, or contract purchaser files the application, the agent, lessee, or contract purchaser shall provide the City with written documentation that the owner of the property has authorized the filing of the application.

(b) An application for a sign permit shall be filed with the City of Lakeland on a form prescribed by the City, along with the fee for such application as contained in Appendix "A" of the City Code of Lakeland, Tennessee.

(c) Each application for a sign permit shall contain information required on the application form, and such other information regarding the proposed sign as the City and/or Design Review Commission may deem necessary in order to determine whether the proposed sign(s) complies with the



## ORDINANCE 16-245

applicable requirements of this Ordinance and other applicable ordinances of the City.

(d) The City shall determine whether the application is complete. If the City determines that the application is not complete, then it shall notify the applicant of any deficiencies and shall take no further steps to process the application until the applicant remedies the deficiencies.

(3) **Fees.** The permit fee for each sign allowed under the requirements of this Ordinance shall be as prescribed in Appendix “A” of the City Code of Lakeland, Tennessee.

(4) **Plan Submittal Required.** A Sign Plan is required for all residential subdivisions, multifamily and townhome developments, planned unit developments, non-residential subdivisions, non-residential developments, and all multi-building or multi-occupant non-residential developments before any signs for such development may be erected on the property. All owners, tenants, subtenants and purchasers of individual units within the development shall comply with the Sign Plan approved by the City of Lakeland.

(5) **Sign Plan Elements.** The Sign Plan shall consist of five distinct design elements that shall govern all signs within the development: location, materials, size, color and illumination. The Sign Plan shall include details, specifications, dimensions, and plans showing the proposed locations of sign and how such locations conform to the requirements of this Ordinance. Material samples proposed for use on sign shall be included with submittal of plan documents. A full-color rendered site plan and elevation drawing shall be included with the submittal of plan documents. The Sign Plan shall also show the computations of the maximum total sign area permitted for the site.

(6) **Plan Review Procedure.** A Sign Plan shall be submitted for review and approval by the Design Review Commission. Prior to consideration of a Sign Plan by the Design Review Commission, the applicant shall meet with City staff to review the sign elements relative to applicable provisions of this Ordinance. City staff shall provide a written report to the Design Review Commission outlining their findings for consideration by the Commission during the review of the Sign Plan. The Design Review Commission shall review the Sign Plan in accordance with Section 14-408.1 of this Ordinance.

(7) **Plan Review Criteria.** A Sign Plan for a residential or non-residential subdivision, planned unit development, non-residential structure (single occupant, multi-building or multi-occupant), and other projects proposing the installation of signage requiring review and approval by the Design Review Commission and issuance of a Sign Permit, shall not be approved until and unless the City finds that:

(a) The Sign Plan provides that signs of a similar type and function within the development will have a consistent color scheme, architectural style, and material construction; and

(b) The Sign Plan provides for signs that meet the size limitations, location requirements, and other applicable requirements of this Ordinance are context sensitive and fit the massing, scale, design theme, architectural style of

## ORDINANCE 16-245

the buildings and are generally consistent with the provisions contained in the remainder of this ordinance. The DRC may approve sign plan elements that vary from the general requirements of the Sign Ordinance if the applicant can demonstrate how the varied standards are contextually appropriate and would enhance the overall project. Any sign standard not provided in the sign plan shall be controlled by the sign ordinance.

(8) **Amendment to Approved Sign Plan.** An approved Sign Plan may be amended by filing a new Sign Plan with City:

(a) The application may be filed only by the owner of the land affected by the proposed change; or an agent, lessee or contract purchaser specifically authorized by the owner to file such application. Before filing the application, all landowners affected by the proposed change must give written authorization.

(b) Any new or amended Sign Plan (including those for Planned Unit Developments) shall include a schedule for bringing into conformance within 90 days all signs not conforming to the proposed plan. This shall apply to all properties governed by the Sign Plan.

(9) **Effect of Approval of Sign Plan.** After approval of a Sign Plan, or an amended Sign Plan, no sign shall be erected, placed, painted, or maintained, except in accordance with such plan, and such plan may be enforced in the same way as any provision of this Ordinance. ~~In case of any conflict between a provision of the approved Sign Plan and one or more provisions of this Ordinance, the Ordinance shall control.~~

(10) **Lapse of Sign Permit.** A sign permit shall lapse automatically if the business license for the premises lapses or is revoked or not renewed. A sign permit shall also lapse if the business is discontinued for a period of 90 days or more.

(11) **Permits for Temporary Signs.** Temporary signs on private property shall be allowed only in accordance with the provisions of Section 14-404.2 (17) of this Ordinance and only upon issuance of a Temporary Sign Permit, which shall be subject to the following terms:

(a) ~~A Temporary Sign Permit shall allow the use of a temporary sign for a specified 30-day period.~~

(b) ~~Only one (1) Temporary Sign Permit shall be issued to the same business address holder on the same site for the same business.~~

(c) ~~Only two (2) Temporary Sign Permits shall be issued to the same business address in a calendar year regardless of change in occupancy or ownership of property.~~

(d) Temporary signs shall not require the review and approval by the Design Review Commission prior to issuance of a Temporary Sign Permit.

(12) **Removal of Signs upon Discontinuance of Use.** Whenever the use of a building or premises by a specific business or other establishment is discontinued by the owner or occupant for a period of 90 days, the sign permits for all signs pertaining to that business or establishment that were installed by the occupant or owner shall be deemed to have lapsed, and the signs shall be removed at the expense of the occupant and/or owner, as well as all signs and related structural members which do not conform to the

## ORDINANCE 16-245

standards of this Ordinance. The Sign Plan approved by the City, if applicable, shall remain in effect provided it does not conflict with the requirements of this Ordinance.

### 14-410 Variances

(1) **Purpose.** Where a literal application of the terms of this Ordinance, due to special circumstances, would result in an unusual hardship in an individual case, the Design Review Commission may grant a variance to the number of colors, use of logos and trademarks, location, orientation, illumination, and other related design elements for permitted signs as specifically provided for in various sections of this Ordinance and pursuant to procedures set forth in City Code, where all the following conditions exist:

(a) Exceptional conditions pertaining to the property where the sign is to be located as a result of its size, shape or topography, which are not applicable generally to other lands or structures in the area.

(b) The applicant would be deprived of rights that are commonly enjoyed by others similarly situated.

(c) Granting the variance would not confer on the applicant any significant privileges that are denied to others similarly situated.

(d) The exceptional circumstances are not the result of action by the applicant.

(e) The requested variance is the minimum variance necessary to allow the applicant to enjoy the rights commonly enjoyed by others similar situated.

(f) Granting of the variance would not violate more than one standard of this Ordinance.

(g) Granting of the variance would not result in allowing a sign that interferes with road or highway visibility or obstruct or otherwise interfere with the safe and orderly movement of vehicular and pedestrian traffic.

(2) **Variance Allowed.** A request for variance from the Sign Ordinance shall be submitted to the Design Review Commission through the City of Lakeland. Final review of the variance shall be based upon the criteria enumerated in Section 14-410.1 of this Ordinance. No variance shall be granted to the height or setback requirement in excess of ten (10) percent of the prescribed standards in this article. The Design Review Commission may allow variances to dimensional requirements for wall sign area (not the method of computation) that permit an increase above the maximum sign area provided there is suitable wall surface and building massing upon which to place a larger wall sign.

### 14-411 Inspection, Removal and Safety

(1) **Repair and/or Replacement of Signs.** It shall be the obligation of the Code Enforcement Official to maintain routine inspections upon all signs in the City of Lakeland, independently and/or upon the referral of the Design Review Commission. The Code Enforcement Official will perform routine inspections to insure all signs are

## ORDINANCE 16-245

reasonably maintained, promptly repaired, remain in compliance with this Ordinance and still exhort the business of the occupant. In the event that the Code Enforcement Official determines that a sign is deficient as above recited, he shall cause to be delivered a formal written notice to the owner and/or occupant directing the correction of the deficiency within ten (10) days. Upon failure to properly correct the deficiency of said notice within the time allotted, the sign shall be rendered an illegal sign subject to the enforcement provisions as hereinbefore provided.

### (2) Annual Inspection Required.

(a) The City of Lakeland shall inspect once annually on or about the anniversary date of this Ordinance signs properly permitted by this Ordinance; provided, however, single-family subdivision entrance signs are exempt from the annual inspection requirement.

(b) All signs and components thereof shall be kept in good repair and in safe, neat, clean and attractive condition.

~~(3) Permit Number Display. All signs requiring a permit shall display said permit number in three fourths (3/4) inch numerals in the lower right hand corner of said sign. If said sign is a temporary sign, the expiration date for the permit shall also be so displayed.~~

(4) **Removal of Illegal Signs Required.** All illegal signs shall be removed within sixty (60) days from the effective date of this Ordinance.

(5) **Notice to Remove Illegal Sign.** In addition to the other rights and privileges created hereby, the Code Enforcement Official, upon determining that a sign, sign structure, or appurtenance thereto, is in violation of the Ordinance, may in addition to other penalties, deliver notice to the owner and/or occupant to remove the illegal sign within ten (10) days. The Code Enforcement Official may also cause to be issued summons by the Clerk of any court having jurisdiction over said violation, citing the violator to appear and answer the charge of violation before said court, which finding may be appealed as any other conviction of an Ordinance violation to the Circuit Court.

~~(6) Burden of Documentation Upon Sign Owner and Occupant. After the date of adoption of this Ordinance on June 27, 2003, any sign owner or occupant alleging that his sign is a non-conforming sign, as opposed to an illegal sign, shall within sixty (60) days from the effective date of this Ordinance, deliver a certified and dated copy of the original sign permit under which the sign was first erected, demonstrating that the subject sign was, in fact, in compliance and approved under then existing regulations and, further, that said approval was not based upon an excess of or variance to said regulations. Failure to so document the original permit shall render said sign an illegal sign and subject to immediate removal as an illegal sign as herein provided.~~

### (7) Removal of Sign.

(a) Temporary signs erected or maintained in violation of this chapter shall be removed by the Code Enforcement Official or his designee without notice.

(b) The Code Enforcement Official or his designee shall

## ORDINANCE 16-245

remove any sign immediately and without notice if the sign presents an immediate threat to the safety of the public.

(c) Any sign removal shall be at the expense of the property owner.

(8) **Removal of Abandoned Signs.** All signs that no longer correctly direct or exhort any person, advertise a bona fide business in progress, lessor, owner, project or activity conducted or product available shall be removed within thirty (30) days from the cessation of said activity.

(9) **Removal of Unsafe Structures.** Upon notice by the Code Enforcement Official to the owner or occupant of property upon which an illegal sign, an unsafe sign, unsafe sign structure or unsafe appurtenance thereto, is located, the said owner or occupant, within twenty-four (24) hours, shall remove same, or in the alternative, with the leave of the City Manager, the Code Enforcement Official or his designee may remove same or provide for its immediate removal - the cost of said removal to be borne by the owner and/or occupant.

(10) **Provisions of Federal and State Law Expected.** No provision of this Ordinance shall contravene by term or application any existing or later enacted statute or regulation of the Federal or State governments, and in the event of said conflict, the provisions of the State and/or Federal regulations shall control, and signs permitted by said statute may be erected in size, dimensions, set-back and design at the MINIMUM requirements of said State and/or Federal law or regulation, and subject to the review and approval of the Design and Review Commission and upon reference to the City Attorney upon his certification of the law to the Design and Review Commission.

### 14-412. Nonconforming Signs.

It is the policy of the City of Lakeland to encourage that all signs within the City be brought into compliance with the terms and requirements of this Ordinance.

(1) **Nonconforming Signs Adversely Affect Public Health, Safety and Welfare.** The City finds that non-conforming signs may adversely affect the public health, safety and welfare. Such signs adversely affect the aesthetic characteristics of the City and may adversely affect public safety due to visual impact of said signs on motorists and the structural characteristics of said signs. Accordingly, the following registration requirements are found to be necessary in order to minimize these possible adverse effects through annual inspections and maintenance and allow the City to remain cognizant of the locations and maintenance of said signs.

#### ~~(2) Registration of Nonconforming Signs:~~

a. The owner(s) or authorized agent(s) of each nonconforming sign located within the City shall register said non-conforming sign with the City no later than 120 days after the effective date of this Ordinance and shall renew this registration annually thereafter.

(b) Any nonconforming sign that does not comply with the registration requirements herein shall be deemed to be an illegal sign and

## ORDINANCE 16-245

shall be subject to the regulations applicable to illegal signs and all other enforcement provisions of this Ordinance.

(c) The City shall promulgate a form for the registration of nonconforming signs and shall annually inspect said signs to assure that they continue in all other respects in conformity with all other provisions of this Ordinance and any other applicable ordinance or regulation of the City.

(3) **Inspection of Nonconforming Signs.** The City may inspect existing signs in the City from time to time to determine if such signs conform to the provisions of this Ordinance.

(4) **Discontinuance of Nonconforming Signs.** Any nonconforming sign, which is not used or leased for a continuous period of 90 days, shall not be reused for sign purposes unless and until it fully conforms to the terms and requirements of this Ordinance.

(5) **Removal of Non-Conforming Signs.** All non-conforming signs provided the non-conformity has been documented as hereinbefore provided shall be removed within the earliest applicable time period or occurrence as specified below:

a. **Off-Premise and Pole Signs.** Within sixty-six (66) months from the effective date of this Ordinance or the date on which the property underlying such signs is annexed into the limits of the City of Lakeland or the date on which such signage is rendered non-conforming by virtue of future amendments to this Ordinance, whichever shall later occur.

b. **Wall Signs.** Within thirty-six (36) months from the effective date of this Ordinance or the date on which the property underlying such signs is annexed into the limits of the City of Lakeland or the date on which such signage is rendered non-conforming by virtue of future amendments to this Ordinance, whichever shall later occur.

c. **Principal Ground Signs.** Within twenty-four (24) months from the effective date of this Ordinance or the date on which the property underlying such signs is annexed into the limits of the City of Lakeland or the date on which such signage is rendered non-conforming by virtue of future amendments to this Ordinance, whichever shall later occur.

d. **Nonconforming due to Illegal Multiple Signage.** Within eighteen (18) months from the effective date of this Ordinance or the date on which the property underlying such signs is annexed into the limits of the City of Lakeland or the date on which such signage is rendered non-conforming by virtue of future amendments to this Ordinance, whichever shall later occur.

e. **All Other Nonconforming Signage.** Within twelve (12) months from the effective date of this Ordinance or the date on which the property underlying such signs is annexed into the limits of the City of Lakeland or the date on which such signage is rendered non-conforming by virtue of future amendments to this Ordinance, whichever shall later occur.

f. **Change in Use.** When the use of a property changes (including but not limited to the redevelopment of the site or a change in use, the signs on that property must be brought into compliance with the requirements of this

## ORDINANCE 16-245

Ordinance.

g. Abandonment. Any sign related to a use or business that ceases to exist or operate for a continuous period of 90 days shall be considered nonconforming and shall not be reused for sign purposes unless and until it is in full conformity with the provisions of this Ordinance, subject to issuance of a new sign permit.

h. Alterations to Nonconforming Signs. No alterations to a nonconforming sign or sign structure shall be permitted except minor repairs and maintenance. Any structural or other substantial maintenance or improvement to a nonconforming sign (except painting or refinishing the surface of the existing sign face or sign structure so as to maintain proper appearance) shall be deemed an abandonment of the nonconforming status, shall render any prior permit void, and shall result in the reclassification of such sign as an illegal sign.

(6) **Alteration, Expansion, Moving.** No nonconforming sign shall be changed or altered in any manner which would increase the degree of its nonconformity, be expanded, altered to prolong its useful life, or removed in whole or part to any other location where it would be nonconforming.

(7) **Damage or Destruction.** In the event that any nonconforming sign is damaged or destroyed by any means, to the extent of more than fifty percent (50%) of the fair market value of such sign immediately prior to such damage or destruction, such sign shall not be restored unless it shall thereafter, conform to this Ordinance.

(8) **Maintenance and Repair of Nonconforming Signs.** No structural repairs, change in shape, size or design, shall be permitted except to make a nonconforming sign comply with all requirements of this Ordinance.

(9) **Other Sign Permits On Premises.**

(a) For single occupant properties, the issuance of a sign permit for a new or replacement sign shall be subject to the condition that all nonconforming signs on that property shall be removed or brought into compliance as part of the work of installing the new or replacement sign.

(b) For multi-occupant properties, the issuance of a sign permit for a new or replacement sign for any individual occupant shall be subject to the condition that all nonconforming signs for that occupant shall be removed or brought into compliance as part of the work of installing the new or replaced sign.

(c) This section shall not apply to the issuance of a permit for a temporary sign.



## ORDINANCE 16-245

(10) **Required Removal.** Where an amendment to a previously approved development plan is proposed, approval of such plan shall be contingent upon removal of all nonconforming signs on the site. For example, if an existing retail establishment proposed a building addition or parking expansion, then any nonconforming signs on the property must be brought into compliance as a condition of approval of the amended site plan.

(11) **Replacement of Nonconforming Sign.** Another nonconforming sign may not replace a nonconforming sign.

~~(12) — Sign as a Nonconforming Primary Use.~~

~~(a) In the circumstance where a sign itself is a primary use of the property upon which it is erected as defined under this Ordinance, the burden shall be upon the owner of said sign to document within sixty (60) days from the effective date of this Ordinance:~~

~~(b) That the sign is, in fact, a non-conforming sign legally erected without variance under prior regulations;~~

~~(c) That the sign is, in fact, the primary use of the property, being neither auxiliary to, nor appurtenant to, nor directional to, nor the advertisement of adjacent businesses or uses;~~

~~(d) Upon proper documentation as above provided, the use may be continued and the owner shall make application within sixty (60) days of the effective date of this Ordinance, to the Design and Review Commission, in the ordinary course, whose responsibility it shall be, upon the advice and recommendation of law enforcement, fire department, and building inspection officials having jurisdiction within the City of Lakeland, to require such modification in size, copy, location with respect to streets, ingress and egress, lighting and traffic parameters to remove hazards to safety and/or encroachments upon adjacent occupants.~~

~~(e) The failure of documentation shall render the sign an illegal sign subject to removal and the penalties hereinafter provided.~~

### 14-413 Severability.

The provisions of this Ordinance are severable. If any provision of this Ordinance or the application thereof to any person or circumstance is held to be invalid by a court of competent jurisdiction, such invalidity shall not affect other provisions or applications of this Ordinance that can be given effect without the invalid provision or application.

### 14-414 Effective Date.

This Ordinance shall take effect immediately after its final passage, the public welfare requiring it.

### 14-415 Repeal of Conflicting Ordinances.

All prior Ordinances relating to signs are hereby repealed and the provisions of this Ordinance shall control all regulation of signs in the City of Lakeland.